

EPP Termobox EPP Thermobox

(Üstten Yükleme / Top Loading)

GIDA TAŞIMACILIĞINDA SON İNOVASYON THE LATEST INNOVATION IN FOOD TRANSPORTATION

- Made for GN containers 60x40 trays
- Front loader
- Possibility to handle from 4 sides
- Smooth opening and closing
- Resistant to liquids dripping
- Door opens up to 270°
- 6 built-in rails for 60x40 trays



- Specially made for bakery crates
- Top loader
- Embedded ergonomic handles

Ürün Kodu Code	EPP-4060FL
Renkler Colors	Black
İç Boyutları Int. Dimensions	L: 615xW: 410xH: 585 mm
Dış Boyutları Ext. Dimensions	L: 770xW: 535xH: 689 mm
Net Ağırlığı Net Weight	6,50 Kg
Maks. Kapasite Max. Capacity	126 L



EPP-4060FL

Ürün Kodu Code	EPP-406020TL
Renkler Colors	Black
İç Boyutları Int. Dimensions	L: 625xW: 425xH: 205 mm
Dış Boyutları Ext. Dimensions	L: 690xW: 490xH: 269 mm
Net Ağırlığı Net Weight	1,3 Kg
Maks. Kapasite Max. Capacity	53 L



EPP-406020TL

Ürün Kodu Code	EPP-406030TL
Renkler Colors	Black
İç Boyutları Int. Dimensions	L: 625xW: 425xH: 305 mm
Dış Boyutları Ext. Dimensions	L: 690xW: 490xH: 369 mm
Net Ağırlığı Net Weight	1,6 Kg
Maks. Kapasite Max. Capacity	81 L



EPP-406030TL



EPP Termobox EPP Thermobox

(Önden Yüklümel / Front Loading)



EPP-600



EPP-600

GIDA TAŞIMACILIĞINDA SON İNOVASYON THE LATEST INNOVATION IN FOOD TRANSPORTATION

Özellikler / Features

- Mükemmel izolasyon. (-40°C +120°C)
- Genleştirilmiş Polipropilen (EPP)'den üretilmiştir.
- Darbeye dayanıklı ve hafiftir.
- Sıcak, soğuk ve taze gıdalar için uygundur.
- Hijyeniktir ve bulaşık makinesinde yıkanabilir.
- 100% geri dönüşümlüdür.
- Sıkı geçme kapaklıdır.
- EC-1935/2004, düzenlemesi gereği gıda temasına uygundur.
- Kloroflorokarbon (CFC) içermez.
- Excellent insulation (from -40°C up to +120°C) with high thermal stability.
- Robust, made of EPP
- Durable and lightweight.
- Perfect for hot, cold and fresh food.
- Hygienic and dishwasher-proof.
- 100% recyclable.
- Tightly closing lid.
- In compliance with EC-regulation 1935/2004, safe for food contact.
- CFC free.

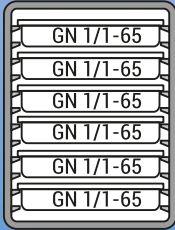

51 L
GN 1/1-65 x 6 Pcs

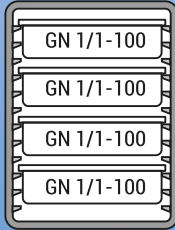

52,5 L
GN 1/1-100 x 4 Pcs

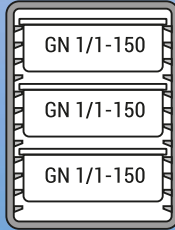

58,5 L
GN 1/1-150 x 3 Pcs

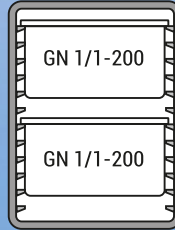

51 L
GN 1/1-200 x 2 Pcs

Ürün Kodu Code	EPP-600
Renkler Colors	Siyah, Black
İç Boyutları Int. Dimensions	L:530 x W:330 x H:525 mm
Dış Boyutları Ext. Dimensions	L:630 x W:440 x H:630 mm
Koli İçi Adedi Quantity	1 Adet/Pcs.
Net Ağırlığı Net Weight	3,80 Kg
Maks. Kapasite Max. Capacity	86 L



EPP Termobox EPP Thermobox

(Üstten Yüklenebilir / Top Loading)

GIDA TAŞIMACILIĞINDA SON İNOVASYON THE LATEST INNOVATION IN FOOD TRANSPORTATION

Özellikler / Features

- Mükemmel izolasyon. (-40°C +120°C)
 - Genleştirilmiş Polipropilen (EPP)'den üretilmiştir.
 - Darbeye dayanıklı ve hafiftir.
 - Sıcak, soğuk ve taze gıdalar için uygundur.
 - Hijyeniktir ve bulaşık makinesinde yıkanabilir.
 - 100% geri dönüşümlüdür.
 - Sıkı geçme kapaklıdır.
 - EC-1935/2004, düzenlemesi gereği gıda temasına uygundur.
 - Kloroflorokarbon (CFC) içermez.
- Excellent insulation (from -40°C up to +120°C) with high thermal stability.
 - Robust, made of EPP
 - Durable and lightweight.
 - Perfect for hot, cold and fresh food.
 - Hygienic and dishwasher-proof.
 - 100% recyclable.
 - Tightly closing lid.
 - In compliance with EC-regulation 1935/2004, safe for food contact.
 - CFC free.

25,5 L GN 1/1-200	28 L GN 1/1-65 GN 1/1-150	26 L GN 1/1-100 GN 1/1-100
21,5 L GN 1/1-65 GN 1/1-100	25,5 L GN 1/1-65 GN 1/1-65 GN 1/1-65	



EPP-200

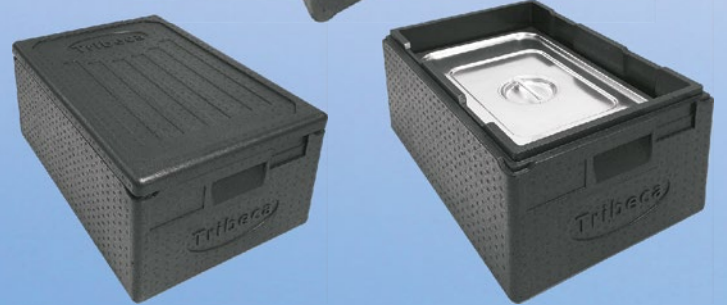

Ürün Kodu Code	EPP-200
Renkler Colors	Siyah, Black
İç Boyutları Int. Dimensions	L: 538xW: 338xH: 253 mm
Dış Boyutları Ext. Dimensions	L: 600xW: 400xH: 316 mm
Koli Boyutları Carton Size	L: 610xW: 410xH: 325 mm
Koli İçi Adedi Quantity	1 Adet/Pcs.
Net Ağırlığı Net Weight	1,20 Kg
Maks. Kapasite Max. Capacity	46 L



EPP Termobox EPP Thermobox

(Üstten Yükleme / Top Loading)

5

GIDA TAŞIMACILIĞINDA SON İNOVASYON THE LATEST INNOVATION IN FOOD TRANSPORTATION



EPP-3535L

- Specially made for pizza transport
- Top loader
- Steam vent to keep pizzas crispy
- Can hold up to 4 pizzas



EPP-3535H

- Specially made for pizza transport
- Top loader
- Steam vent to keep pizzas crispy
- Can hold up to 8 pizzas

Ürün Kodu Code	EPP-3535L	EPP-3535H
Renkler Colors	Black	Black
İç Boyutları Int. Dimensions	L: 365xW: 350xH: 175 mm	L: 365xW: 350xH: 335 mm
Dış Boyutları Ext. Dimensions	L: 425xW: 410xH: 235 mm	L: 425xW: 410xH: 395 mm
Net Ağırlığı Net Weight	0,7 Kg	1 Kg
Maks. Kapasite Max. Capacity	22 L / 4 Pizzas	43 L / 8 Pizzas



EPP-4242L

- Specially made for pizza transport
- Top loader
- Steam vent to keep pizzas crispy
- Can hold up to 4 pizzas



EPP-4242H

- Specially made for pizza transport
- Top loader
- Steam vent to keep pizzas crispy
- Can hold up to 8 pizzas

Ürün Kodu Code	EPP-4242L	EPP-4242H
Renkler Colors	Black	Black
İç Boyutları Int. Dimensions	L: 420xW: 420xH: 175 mm	L: 420xW: 420xH: 335 mm
Dış Boyutları Ext. Dimensions	L: 480xW: 480xH: 245 mm	L: 480xW: 480xH: 405 mm
Net Ağırlığı Net Weight	1 Kg	1,3 Kg
Maks. Kapasite Max. Capacity	31 L / 4 Pizzas	59 L / 8 Pizzas



EPP Termobox EPP Thermobox

(Üstten Yükleme / Top Loading)

GIDA TAŞIMACILIĞINDA SON İNOVASYON THE LATEST INNOVATION IN FOOD TRANSPORTATION



EPP-MBP

- Specially made for cold and hot food transport (big-size pizza, salads and soft drinks)
- Cold / Hot separation
- Front loader
- Drip-resistant
- Easy key locking
- Large label area in 4 sides
- Steam vent to keep pizzas crispy

Ürün Kodu Code	EPP-MBP
Renkler Colors	Black
İç Boyutları Int. Dimensions	L:420xW: 491xH: 408 mm
Dış Boyutları Ext. Dimensions	L: 570xW: 602xH: 575 mm
Net Ağırlığı Net Weight	4,4 Kg
Maks. Kapasite Max. Capacity	100 L

- Specially made for mixed cold and hot food transport (big-size pizza, salads and soft drinks)
- Cold / Hot separation
- Pizza Box (EPP-3535L)
- Front loader
- Drip-resistant
- Easy key locking
- Large label area in 4 sides
- Steam vent to keep pizzas crispy

Ürün Kodu Code	EPP-MBPF (EPP-MBP + EPP-3535L)
Renkler Colors	Black
İç Boyutları Int. Dimensions	L:420xW: 491xH: 408 mm
Dış Boyutları Ext. Dimensions	L: 570xW: 602xH: 575 mm
Net Ağırlığı Net Weight	4,4 Kg
Maks. Kapasite Max. Capacity	100 L



EPP-MBPF (EPP-MBP + EPP-3535L)



Termobox Thermobox

(Önden Yüklemeli / Front Loading)

TCB-600

TCB-600



Ürün Kodu Code	TCB-600
Renkler Colors	Gri, Kahve, Haki, Mavi, Siyah Grey, Brown, Army, Blue, Black
İç Boyutları Int. Dimensions	L: 335xW: 515xH: 500 mm
Dış Boyutları Ext. Dimensions	L: 465xW: 610xH: 630 mm
Koli Boyutları Carton Size	L: 660xW: 500xH: 655 mm
Koli İçi Adedi Quantity	1 Adet/Pcs.
Net Ağırlığı Net Weight	15,90 Kg
Brüt Ağırlığı Gross Weight	17,90 Kg
Maks. Kapasite Max. Capacity	58,8 Kg

Özellikler / Features

- GN Küvetlere göre tasarlanmıştır. 12 adet raf kızağı vardır. Raf aralığı 30mm'dir.
- Gıdaya uygun, insan sağlığına zararsız polietilenden üretilmiştir. Geri dönüşümlü olduğundan çevre dostu bir üründür.
- Yalıtım için çift cidarlı üretilerek, iç ve dış duvarlar arasında 38-40 kg/m³ yoğunlukta poliüretan (CFC-FREE) enjekte edilmiştir.
- Monoblok tek seferde üretilmiş gövdesi vardır. Bu, ürün dayanıklılığını arttırmaktadır.
- Sol tarafa doğru 270°C açılan polipropilen menteşeli kapısı sayesinde çapraz bulaşmanın önüne geçildiği için daha hijyeniktir.
- Yükleme kapısı kilidi için kullanılan tüm vidalar 304 kalite paslanmaz çeliktedir.
- Yükleme kapısı menteşeli olup kırılmaz PA.6 (Poliamid) malzemeden üretilmiştir.
- Kolay taşınabilmesi için gövdenin üzerinde dayanıklı monoblok kulplar vardır.
- Depolamada, taşımada ve kullanımda kolaylık olması amacıyla üst üste istiflenecek şekilde tasarlanmıştır.
- Önden yüklemelidir. -40°C soğuğa, +100°C sığağa dayanıklıdır.
- 4 saat boyunca, sıcak yemekler saatte ortalama 1,5°C soğur, soğuk yemeklerle 1°C ısınır.
- Kapı içinde gıdaya uygun silikondan üretilmiş yuvarlak conta bulunmaktadır.
- Bulaşık makinesinde yıkanabilir.
- Gövdesi, kullanılan hammaddede ve üretim tekniğinden dolayı çok dayanıklı olup, pabuç ve köşe koruma kullanılmasına gerek yoktur.

TCB-600C

Termobox Taşıma Arabası
Thermobox Carrying Cart

Ürün Kodu Code	TCB-600C
Renkler Colors	Siyah / Black
Dış Boyutları Ext. Dimensions	L: 680xW: 540xH: 160 mm
Koli Boyutları Carton Size	L: 690xW: 185xH: 550 mm
Koli İçi Adedi Quantity	1 Adet/Pcs.
Net Ağırlığı Net Weight	5,70 Kg
Brüt Ağırlığı Gross Weight	6,70 Kg

	ADET/PCS.	PORSİYON POSITION
GN 1/1 - 20 mm	12	120
GN 1/1 - 65 mm	6	216
GN 1/1 - 100 mm	4	224
GN 1/1 - 150 mm	3	252
GN 1/1 - 200 mm	2	234

- Made by rotational-molding (roto-molded) technology that ensures impact resistance and long-term durability.
- Made of low density polyethylene which is suitable for food and harmless for human health.
- Food grade LLDPE material which is eco-friendly, recyclable, non-toxic, UV resistant, resistant to both heat, cold and corrosion.
- Designed for standard GASTRONORM containers. It includes 12 shelving areas for GN containers with a shelving range of 30 mm.
- One-piece seamless construction which makes it leak-proof.
- Injected with 38 - 40 kg/m³ density CFC-free polyurethane between the internal and external walls making a double wall. Thick polyurethane insulation layer (2.3") for a longer heat-retention effect.
- Monobloc construction with no seams for increased durability.
- Polyethylene door that swings open to 270° to the left side reducing the risk of cross contamination.
- All screws are made by AISI 304 stainless steel.
- Door is equipped with hinges and latches made of unbreakable PA6 Nylon.
- The monobloc ergonomic handles are fixed in a convenient height making transportation easier even if when the thermobox is fully charged with food.
- Stackable design for easy transportation and carriage.
- Front loading. Heat resistance from -40 to +100 °C. For hot meals it loses 1.5 degree per hour and heats up 1 degree for cold meals.
- Round door gasket made by FDA approved silicone.
- Very durable construction due to the raw material and the body manufacturing technique with no need for extra protection.

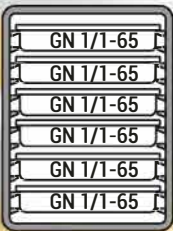

51 L
GN 1/1-65 x 6 Pcs

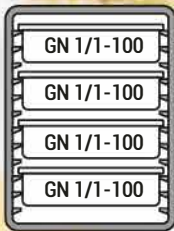

52,5 L
GN 1/1-100 x 4 Pcs

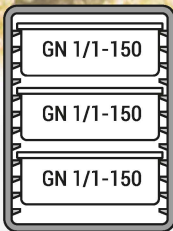

58,5 L
GN 1/1-150 x 3 Pcs

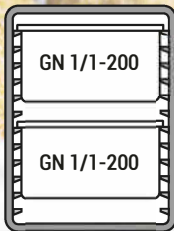

51 L
GN 1/1-200 x 2 Pcs

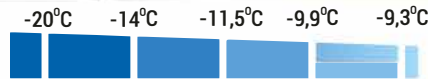
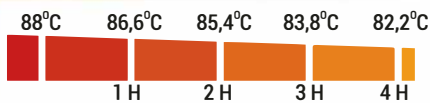

Özellikler / Features

- Gıdaya uygun, insan sağlığına zararsız polietilenden üretilmiştir.
- Geri dönüşümlü olduğundan çevre dostu bir üründür.
- Yalıtım için çift cidarlı üretilerek, iç ve dış duvarlar arasında 38-40 kg yoğunlukta poliüretan (CFC-FREE) enjekte edilmiştir.
- Monoblok tek seferde üretilmiş gövdesi vardır. Bu da dayanıklılığı arttırmaktadır.
- Kilitleri kırılmaz PA6'dan üretilmiştir.
- Kolay taşınabilmesi için gövdenin üzerinde monoblok oyuntuları vardır.
- Depolamada, taşımada ve kullanımda kolaylık olması amacıyla üst üste istiflenecek şekilde tasarlanmıştır.
- Üstten yüklemelidir. -40°C soğuğa, +100°C sığağa dayanıklıdır.
- Bulaşık makinesinde yıkanabilir.
- Gövdesi, kullanılan hammadde ve üretim tekniğinden dolayı çok dayanıklı olup pabuç ve köşe koruma kullanılmasına gerek yoktur.

- Made by rotational-molding (roto-molded) technology that ensures impact resistance and long-term durability.
- Made of low density polyethylene which is suitable for food and harmless for human health.
- Food grade LLDPE material which is eco-friendly, recyclable, non-toxic, UV resistant, resistant to both heat, cold and corrosion.
- Designed for standard GASTRONORM containers.
- One-piece seamless construction which makes it leak-proof.
- Injected with 38 – 40 kg/m³ density CFC-free polyurethane between the internal and external walls making a double wall. Thick polyurethane insulation layer (2.3") for a longer heat-retention effect.
- Monobloc construction with no seams for increased durability.
- All screws are made by AISI 304 stainless steel.
- Door is equipped with hinges and latches made of unbreakable PA6 Nylon.
- The monobloc ergonomic handles are fixed in a convenient height making transportation easier even if when the thermobox is fully charged with food.
- Stackable design for easy transportation and carriage.
- Top Loading. Heat resistance from -40 to +100 °C.
- For hot meals it loses 1.5 degree per hour and heats up 1 degree for cold meals.
- Very durable construction due to the raw material and the body manufacturing technique with no need for extra protection.

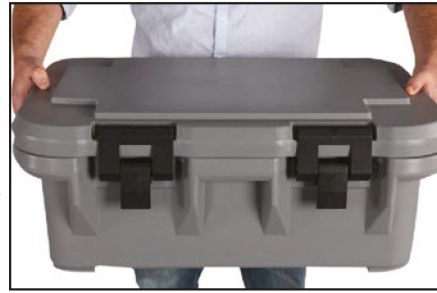

SICAK/HOT

TCB-100	87°C	85°C	83°C	81°C	79°C
TCB-150	87°C	85°C	83°C	81°C	79°C
TCB-200	87°C	85°C	83°C	81°C	79°C



SOĞUK/COLD

TCB-100	0°C	1°C	2°C	2°C	2.5°C
TCB-150	0°C	1°C	2°C	2°C	2.5°C
TCB-200	0°C	1°C	2°C	2°C	2.5°C

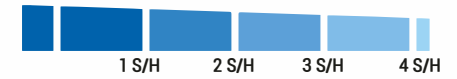

GN1/1 1 Adet/Pcs.



GN1/2 2 Adet/Pcs.



GN1/3 3 Adet/Pcs.

TCB 100	TCB 150	TCB 200
GN 1/1-100mm(1 Adet/Pcs.)x56 Pors./Port.	GN 1/1-150mm(1 Adet/Pcs.)x84 Pors./Port.	GN 1/1-200mm(1 Adet/Pcs.)x112 Pors./Port.
GN 1/2-100mm(2 Adet/Pcs.)x24 Pors./Port.	GN 1/2-150mm(2 Adet/Pcs.)x36 Pors./Port.	GN 1/2-200mm(2 Adet/Pcs.)x50 Pors./Port.
GN 1/3-100mm(3 Adet/Pcs.)x16 Pors./Port.	GN 1/3-150mm(3 Adet/Pcs.)x23 Pors./Port.	GN 1/3-200mm(3 Adet/Pcs.)x31 Pors./Port.

Ürün Kodu Code	TCB 100	TCB 150	TCB 200
Renkler Colors	Gri, Kahve, Haki, Mavi, Siyah Grey, Brown, Army, Blue, Black	Gri, Kahve, Haki, Mavi, Siyah Grey, Brown, Army, Blue, Black	Gri, Kahve, Haki, Mavi, Siyah Grey, Brown, Army, Blue, Black
İç Boyutları Int. Dimensions	L: 550xW: 350xH: 110 mm	L: 550xW: 350xH: 160 mm	L: 550xW: 350xH: 210 mm
Dış Boyutları Ext. Dimensions	L: 635xW: 435xH: 200 mm	L: 635xW: 435xH: 250 mm	L: 635xW: 435xH: 310 mm
Koli Boyutları Carton Size	L: 650xW: 455xH: 230 mm	L: 650xW: 455xH: 280 mm	L: 650xW: 455xH: 330 mm
Koli İçi Adedi Quantity	1 Adet/Pcs.	1 Adet/Pcs.	1 Adet/Pcs.
Net Ağırlığı Net Weight	7,10 Kg	7,60 Kg	8,30 Kg
	8 Kg	8,40 Kg	9,40 Kg



TCB-200M



TCB-200C



Ürün Kodu Code	TCB-200M	TCB-200C
Renkler Colors	Gri, Kahve, Haki, Mavi, Siyah Grey, Brown, Army, Blue, Black	Gri, Kahve, Haki, Mavi, Siyah Grey, Brown, Army, Blue, Black
Boyutları Dimensions	L: 420xW: 720xH: 330 mm	L: 635xW: 435xH: 300 mm
Koli Boyutları Carton Size	L: 430xW: 730xH: 300 mm	L: 650xW: 455xH: 330 mm
Koli İçi Adedi Quantity	1 Adet/Pcs.	1 Adet/Pcs.
Net Ağırlığı Net Weight	10,50 Kg	8,40 Kg
Brüt Ağırlığı Gross Weight	12 Kg	9,50 Kg

Özellikler / Features

- Gıdaya uygun, insan sağlığına zararsız polietilenden üretilmiştir. Geri dönüşümlü olduğundan çevre dostu bir üründür.
- Yalıtım için çift cidarlı üretilerek, iç ve dış duvarlar arasında 38-40 kg/m³ yoğunlukta poliüretan (CFC-FREE) enjekte edilmiştir.
- Monoblok tek seferde üretilmiş gövdesi vardır. Bu, ürün dayanıklılığını arttırmaktadır.
- Kolay taşınabilmesi için gövdenin üzerinde dayanıklı monoblok kulplar vardır.
- Depolamada, taşımada ve kullanımda kolaylık olması amacıyla üst üste istiflenecek şekilde tasarlanmıştır.
- Önden yüklemelidir. -40°C soğuğa, +100°C sığağa dayanıklıdır.
- 4 saat boyunca, sıcak yemekler saatte ortalama 1,5°C soğur, soğuk yemeklerse 1°C ısınır.
- Kapağın içinde gıda ile teması uygun silikondan üretilmiş yuvarlak conta bulunmaktadır.
- Bulaşık makinesinde yıkanabilir.
- Gövdesi, kullanılan hammadde ve üretim tekniğinden dolayı çok dayanıklı olup pabuç ve köşe koruma kullanılmasına gerek yoktur.

- Made by rotational-molding (roto-molded) technology that ensures impact resistance and long-term durability.
- Made of low density polyethylene which is suitable for food and harmless for human health.
- Food grade LLDPE material which is eco-friendly, recyclable, non-toxic, UV resistant, resistant to both heat, cold and corrosion.
- Designed for standard GASTRONORM containers.
- One-piece seamless construction which makes it leak-proof.
- Injected with 38 - 40 kg/m³ density CFC-free polyurethane between the internal and external walls making a double wall. Thick polyurethane insulation layer (2.3") for a longer heat-retention effect.
- Monobloc construction with no seams for increased durability.
- All screws are made by AISI 304 stainless steel.
- Door is equipped with hinges and latches made of unbreakable PA6 Nylon.
- The monobloc ergonomic handles are fixed in a convenient height making transportation easier even if when the thermobox is fully charged with food.
- Stackable design for easy transportation and carriage.
- Top loading. Heat resistance from -40 to +100 °C. Round door gasket made by FDA approved silicone.
- For hot meals it loses 1.5 degree per hour and heats up 1 degree for cold meals.
- Very durable construction due to the raw material and the body manufacturing technique with no need for extra protection.

İzolasyonlu Sıvı Konteyner Insulated Liquid Beverage Container



ST-10



ST-20



ST-40

Ürün Kodu Code	ST-10	ST-20	ST-40
Renkler Colors	Mavi, Bej, Kahverengi, Siyah, Askeri Yeşil Blue, Beige, Brown, Black, Army Green	Mavi, Bej, Kahverengi, Siyah, Askeri Yeşil Blue, Beige, Brown, Black, Army Green	Mavi, Bej, Kahverengi, Siyah, Askeri Yeşil Blue, Beige, Brown, Black, Army Green
Boyutları Dimensions	L: 295xW: 430xH: 500 mm	L: 295xW: 430xH: 675 mm	L: 410xW: 520xH: 635 mm
Koli Boyutları Carton Size	L: 310xW: 435xH: 520 mm	L: 310xW: 435xH: 690 mm	L: 430xW: 530xH: 640 mm
Koli İçi Adedi Quantity	1 Adet/Pcs.	1 Adet/Pcs.	1 Adet/Pcs.
Net Ağırlığı Net Weight	4,80 Kg	7,60 Kg	12,50Kg
Brüt Ağırlığı Gross Weight	5,70 Kg	8,60 Kg	13,60 Kg
Maks. Kapasite Max. Capacity	10 L	20 L	40 L

Özellikler / Features

- Gıdaya uygun, insan sağlığına zararsız polietilenden üretilmiştir. Geri dönüşümlü olduğundan çevre dostu bir üründür.
- Yalıtım için çiftli darlı üretilerek, iç ve dış duvarlar arasında 38-40 kg/m³ yoğunlukta poliüretan (CFC-FREE) enjekte edilmiştir.
- Monoblok tek seferde üretilmiş gövdesi vardır. Bu, ürün dayanıklılığını arttırmaktadır.
- Yükleme kapısı kilidi için kullanılan tüm vidalar 304 kalite paslanmaz çeliktedir.
- Kolay taşınabilmesi için gövdenin üzerinde dayanıklı monoblok kulpları vardır.
- Depolamada, taşımada ve kullanımda kolaylık olması amacıyla üst üste istiflenecek şekilde tasarlanmıştır.
- Üstten yüklemelidir. -40°C soğuğa, +100°C sığağa dayanıklıdır.



- Made by rotational-molding (roto-molded) technology that ensures impact resistance and long-term durability.
- Made of low density polyethylene which is suitable for food and harmless for human health.
- Food grade LLDPE material which is eco-friendly, recyclable, non-toxic, UV resistant, resistant to both heat, cold and corrosion. Ergonomic molded-in handles located on top sides to make them easy lifted for handling and transportation
- One-piece seamless construction. Double walled injected with polyurethane foam between the external and internal walls.
- Nylon latches that open and close easily.
- No-drip black faucet with plastic shank.
- All screws are made by AISI 304 stainless steel.
- Double-walled monobloc polyethylene construction that doesn't dent, crack, rust, chip or break.
- Easy to clean.
- Stackable
- Recyclable and environment-friendly

İzolasyonlu Sıvı Konteyner (İçi Paslanmaz Çelik)

Insulated Liquid Beverage Container (Inside Stainless Steel)



BC-23L



Özellikler / Features

- Gıdaya uygun, insan sağlığına zararsız LLDPE'den üretilmiştir.
- Geri dönüşümlü olduğundan çevre dostu bir üründür.
- Yalıtım için çift cidarlı üretilerek, iç ve dış duvarlar arasında 38-40 kg yoğunlukta poliüretan (CFC-FREE) enjekte edilmiştir.
- Monoblok tek seferde üretilmiş gövdesi vardır. Bu da dayanıklılığı arttırmaktadır.
- Kolay taşınabilmesi için gövdenin üzerinde monoblok oyuntuları vardır.
- Depolamada, taşımada ve kullanımda kolaylık olması amacıyla üst üste istiflenecek şekilde tasarlanmıştır.
- 4 saat boyunca, sıcak yemekler saatte ortalama 1,5°C soğur, soğuk yemeklerse 1°C ısınır.
- Bulaşık makinesinde yıkanabilir.
- Gövdesi, kullanılan hammadde ve üretim tekniğinden dolayı çok dayanıklı olup pabuç ve köşe koruma kullanılmasına gerek yoktur.
- İçi 304 kalite paslanmaz çeliktir.
- 304 kalite paslanmaz çelik kulp ve kilit mandalları vardır.
- Made of LLDPE low density polyethylene which is suitable for food and harmless for human health, recyclable and environmentally friendly.
- Injected with 38 - 40 kg/m3 density polyurethane (CFC-FREE)
- Food grade LLDPE material which is eco-friendly, recyclable, non-toxic, UV resistant, resistant to both heat, cold and corrosion. Ergonomic molded-in handles located on top sides to make them easy lifted for handling and transportation
- One-piece seamless construction. Double walled injected with polyurethane foam between the external and internal walls.
- Monobloc construction with no seams for increased durability.
- Molded-in unbreakable top handle.
- Stackable design for easy transportation and carriage.
- Top loading. Heat resistance between -40 and +100 °C. For hot meals it loses 1.5 degree per hour and heats up 1 degree for cold meals.
- Very durable construction due to the raw material and the body manufacturing technique with no need for extra protection.
- AISI 304 18/10 Stainless Steel inner line.
- AISI 304 18/10 Stainless Steel latches for easy lifting and handling.
- Removable lid with inner Stainless Steel line equipped with silicone gasket.
- No-drip black faucet with plastic shank.

Ürün Kodu Code	BC-23L	RF-33L
Renkler Colors	Mavi, Gri, Kahve, Haki, Siyah Blue, Grey, Brown, Army Green, Black	Mavi, Gri, Kahve, Haki, Siyah Blue, Grey, Brown, Army Green, Black
Dış Boyutları Ext. Dimensions	L: 230xW: 483xH: 745 mm	Ø 420 mm H: 540 mm
Koli Boyutları Carton Size	L: 250xW: 500xH: 760 mm	L: 430xW: 430xH: 550 mm
Koli İçi Adedi Quantity	1 Adet/Pcs.	1 Adet/Pcs.
Net Ağırlığı Net Weight	8,90 Kg	14,20 Kg (Without Pots)
Brüt Ağırlığı Gross Weight	10,10 Kg	15,75 Kg (Without Pots)
Maks. Kapasite Max. Capacity	23 L	

Özellikler / Features

- Ebatları çap 420 mm, h: 540 mm
- İçi 304 kalite paslanmaz çeliktir.
- 33 L kapasitelidir.
- Sıcak ve soğuk gıdalara uygundur.
- Gıdaya uygun polietilenden üretilmiştir.
- CFC-FREE poliüretan ile izolasyon sağlanmıştır.
- Monoblok gövdeye sahiptir.
- Kimyasal yapıdır, kaynak yoktur.
- Kilit ve kulpları paslanmaz çeliktendir.
- İçine isteğe bağlı 2-3-4 adet tencere konulabilir.
- Sulu yemek çeşitleri için idealdir.
- Perfect hygiene. Made from polyethylene for hot and cold food and beverages.
- Robust construction, stackable design. 3 level pots to put and transport different meals.
- CFC FREE polyurethane foam insulation 38 kg/m3.
- AISI 304 18/10 stainless steel inner line.
- AISI 304 18/10 Stainless Steel latches for easy lifting and handling.
- Removable lid with inner Stainless Steel line equipped with silicone gasket.



RF-33L

Özellikler / Features

- Gıdaya uygun, insan sağlığına zararsız polipropilenden üretilmiştir. Geri dönüşümlü olduğundan çevre dostu bir üründür.
- 38-40 kg/m³ (CFC-FREE) poliüretan köpük enjekte edilmiştir.
- +110°C sığağa, -40°C soğuğa dayanıklıdır.
- Tepsiler porselen tabaksız kullanılamaz.
- Depolamada, taşımada ve kullanımda kolaylık olması amacıyla üst üste istiflenecek şekilde tasarlanmıştır.
- Darbe dayanımı çok yüksektir. Kullanımda ve taşımada düştüğünde kırılmaz.
- İç ve dış cidarlar monobloktur. Herhangi bir kimyasal yapışkan kullanılmamıştır.
- Made of polypropylene suitable for food and harmless for human health, environmentally friendly and recyclable.
- Injected with 38 – 40 kg/m³ density polyurethane (CFC-FREE).
- Dishwasher friendly.
- Resists temperatures between -40 and +100 °C.
- Trays cannot be used without plates/crockeries.
- Stackable design allowing easier usage, storage and transport.



OPTION
WITH LOCK

NEW



TT-5N



TT-6N

Tabak Ölçüleri / Plates Dimensions

TT-5N	TT-6N
23 cm Düz Tabak / Flat Plate 20 cm Çukur Tabak / Deep Plate 17 cm Kare Kayık Tabak / Square Oval Plate 12 cm Çorba Kase / Soup Bowl 130 cc Fincan / Cup	23 cm Düz Tabak / Flat Plate 17 cm Kare Kayık Tabak / Square Oval Plate (2 Ad./pcs.) 14 cm Kare Kayık Tabak / Square Oval Plate 12 cm Çorba Kase / Soup Bowl 130 cc Fincan / Cup

Ürün Kodu Code	TT-5N / TT-6N	TTTA-9
Renkler Colors	Bej, Yeşil Beige, Green	Gri, Siyah Grey, Black
Boyutları Dimensions	L: 545xW: 380xH: 120 mm	L: 1005xW: 700xH: 1490 mm
Koli Boyutları Carton Size	L: 560xW: 780xH: 370 mm	L: 1040xW: 730xH: 1510 mm
Koli İçİ Adedi Quantity	6 Adet/Pcs.	1 Adet/Pcs.
Net Ağırlığı Net Weight	18,10 Kg	29,25 Kg
Brüt Ağırlığı Gross Weight	18,90 Kg	31,75 Kg



TTTA-9
9+9 Termo Tepsi Kapasiteli
9+9 Thermo Trays Capacity

Servis Arabası ServiceTrolley

3 Katlı 3 Kenarı Kapalı Monoblok
3 Shelves 3 Sides Closed Monoblock



Ürün Kodu Code	SAK-95
Renkler Colors	Siyah, Kahverengi, Gri Black, Brown, Grey
Dış Boyutları Ext. Dimensions	L: 970xW: 580xH: 880 mm
Koli Boyutları Carton Size	L: 960xW: 585xH: 885 mm
Koli İçi Adedi Quantity	1 Adet/Pcs.
Net Ağırlığı Net Weight	27,50 Kg
Brüt Ağırlığı Gross Weight	30,50 Kg



SAK-95

Özellikler / Features

- 3 katlı, 3 kenarı kapalı monoblok gövdesi, gövdeye gömülü özel somunlarıyla sabitlenmiş tekerlekler sayesinde çok dayanıklı ve sessizdir. Sudan nemden etkilenmez.
- Bulaşık makinesi sepetlerini dışarı yatırmadan rahatlıkla yerleştirebilirsiniz.
- Kirli toplama ve temiz dağıtımında çok elverişlidir.
- Çatlamaz ve kırılmaz.
- Gıdaya uygun, insan sağlığına zararsız polietilenden üretilmiştir.
- Geri dönüşümlü olduğundan çevre dostu bir üründür.
- Dayanıklı olması için, kulpları ve araları dahil gövdesi monoblok olarak ve tek seferde üretilmiştir.
- Çift cidarlı üretilerek, iç ve dış duvarlar arasında poliüretan (CFC-FREE) enjekte edilmiştir.
- Böylece daha fazla ağırlık altında bile görevini sorunsuz olarak yerine getirir.
- Güneş altında ve sıcak küvet taşımaya uygun değildir.
- Servis açma, masalar arasında dolaşmak için idealdir.
- Çöp-Çatal-Kaşık aparatlarını ve Bulaşık Toplama Küvetiyle kullanarak daha verimli çalışabilirsiniz.
- Kolay temizlenebilir.
- 2 frenli ve dönerli, 2 frensiz ve dönerli 4 adet tekerlek ile rahatça hareket ettirilebilir ve durdurulabilir.
- Multi-purpose, handy, substantive and reliable use.
- Made of low density polyethylene which is suitable for food and harmless for human health, recyclable and environmentally friendly.
- Monobloc construction along with handle and shelves which make the trolley highly impact resistance.
- Injected with 38 – 40 kg/m³ density CFC-free polyurethane between the internal and external walls making a double wall handling more weight.
- Easy movement between tables due to 2 swivel wheels and 2 wheels with brakes.
- To be used more efficiently, it must be equipped with cutlery and waste bins
- Easy to clean
- It won't crack, chip or break.
- It is not suitable for use under the sun and carrying a hot GN container.
- Closed back side.



CKA-SA
Çatal Kaşık Aparatı
Cutlery Bin



BTK-01
Bulaşık Toplama Küveti
Bussing Box



CA-SA
Çöp Aparatı
Waste Bin

3 Katlı 2 Kenarı Kapalı Monoblok 3 Shelves 2 Sides Closed Monoblock

Servis Arabası Service Trolley



Özellikler / Features

- Sabitlenmiş tekerlekler sayesinde çok dayanıklı ve sessizdir.
 - Sudan nemden etkilenmez.
 - Bulaşık makinesini sepetlerini dışarı taşımadan rahatlıkla yerleştirebilirsiniz.
 - Kirli toplama ve temiz dağıtımında çok elverişlidir.
 - Çatlamaz ve kırılmaz.
 - Gıdaya uygun, insan sağlığına zararsız polietilenden üretilmiştir.
 - Geri dönüşümlü olduğundan çevre dostu bir üründür.
 - Dayanıklı olması için, kulpları ve araları dahil gövdesi monoblok olarak ve tek seferde üretilmiştir.
 - Çift cidarlı üretilerek, iç ve dış duvarlar arasında poliüretan (CFC-FREE) enjekte edilmiştir. Böylece daha fazla ağırlık altında bile görevini sorunsuz olarak yerine getirir.
 - Güneş altında ve sıcak küvet taşımaya uygun değildir.
 - Servis açma, masalar arasında dolaşmak için idealdir.
 - Çöp-Çatal-Kaşık aparatlarını ve Bulaşık Toplama Küvetiyle kullanarak daha verimli çalışabilirsiniz.
 - Kolay temizlenebilir.
 - 2 frenli ve dönerli, 2 frensiz ve dönerli 4 adet tekerlek ile rahatça hareket ettirilebilir ve durdurulabilir.
- Multi-purpose, handy, substantive and reliable use.
 - Made of low density polyethylene which is suitable for food and harmless for human health, recyclable and environmentally friendly.
 - Monobloc construction along with handle and shelves which make the trolley highly impact resistance.
 - Injected with 38 – 40 kg/m3 density CFC-free polyurethane between the internal and external walls making a double wall handling more weight.
 - Easy movement between tables due to 2 swivel wheels and 2 wheels with brakes.
 - To be used more efficiently, it must be equipped with cutlery and waste bins
 - Easy to clean
 - It won't crack, chip or break.
 - It is not suitable for use under the sun and carrying a hot GN container.
 - Open back side.



SAA-85
Monoblok Açık Model
Monoblock Open Model



SAA-85
Monoblok Açık Model
Monoblock Open Model

Ürün Kodu Code	SAA-85	BTK-01	CKA-SA	CA-SA
Renkler Colors	Siyah, Kahverengi, Gri Black, Brown, Grey	Siyah / Black	Siyah / Black	Siyah / Black
Boyutları Dimensions	L: 850xW: 515xH: 875 mm	L: 470xW: 390xH: 150 mm	L: 280xW: 180xH: 360 mm	L: 345xW: 210xH: 520 mm
Koli Boyutları Carton Size	L: 870xW: 540xH: 910 mm			
Koli İçi Adedi Quantity	1 Adet/Pcs.			
Net Ağırlığı Net Weight	22,10 Kg			
Brüt Ağırlığı Gross Weight	25 Kg			

Servis Arabası • Service Trolley



BO 3152



125 mm



BO 3147

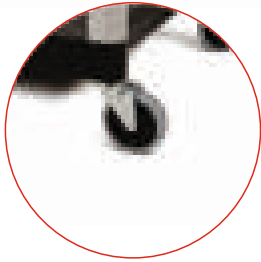

100 mm



Servis Arabası Service Trolley

Kod/Code	Ebat/Size/mm	Koli içi/adedi/ Pcs. in a box	Teker / Caster
BO 3145	525*1060*945 H/mm.	1	125 mm.with 2 brakes -2 Frenli
BO 3146	525*1060*945 H/mm.	1	125 mm. with no brake - Frensiz
BO 3147	525*1060*905 H/mm.	1	100 mm. with no brake -Frensiz
BO 3152	345*255*183 H/mm.	12	10 Lt.
BO 3151	345*255*565 H/mm.	12	29 Lt.
BO 3153	1 Shelf panel set -1 Raf için panel seti	6	

Tepsi Toplama Arabaları Dish & Tray Carts



TTA-3753
37x53 Tepsi için uygundur
Suitable for 37x53 Trays



TTA-3
Self servis hatları ve açık büfe ekipmanlarına uygundur
Suitable for self-service lines and open buffet equipments

Ürün Kodu Code	TTA-3
Renkler Colors	Siyah, Kahverengi Black, Brown
Dış Boyutları Ext. Dimensions	L: 980xW: 585xH: 880 mm
Koli Boyutları Carton Size	L: 1020xW: 585xH: 885 mm
Koli İçi Adedi Quantity	1 Adet/Pcs.
Net Ağırlığı Net Weight	29,80 Kg
Brüt Ağırlığı Gross Weight	32,80 Kg

Özellikler / Features

- Ergonomik dizayn, şık görünümlüdür.
- Her bir bölümünde 12 raf vardır. Çiftli model 24 adet tepsi alır.
- 37x53 cm servis tepsi için imal edilmiş bir tepsi taşıma arabasıdır. Diğer ölçü tepsilere göre de üretilebilir.
- Tepsi rafları arasındaki boşluk sayesinde tepsi, içlerindeki ayaksız su bardaklarıyla birlikte konulabilir.
- Gövdesi gıdaya uygun polietilenden üretilmiştir, dayanıklıdır, paslanmaz ve yıkanabilir.
- Alttan ve üstten rafları birbirine bağlayan 304 kalite paslanmaz çelik profiller kullanılmıştır.
- 2 frenli ve dönerli, 2 frensiz ve dönerli 4 adet tekerlek ile rahatça hareket ettirilebilir ve durdurulabilir.
- Paslanmaz, kırılmaz ve çatlamaz.
- Yandan bakıldığında kirli tepsi görünmez.
- Dekorasyona önem veren işletmeler için çok uygundur.

- Ergonomic design, elegant outlook.
- Made for 24 trays. Double compartments with 12 trays each.
- Manufactured for 37x53 cm service trays. It may be produced for other tray sizes.
- Made of polyethylene so it won't rust. It is also washable and unbreakable.
- Molded by electrostatic paint which attaches the profiles in both sides.
- Provides easy movement by 2 heavy-duty ϕ 125 mm swivel wheels and 2 casters with brakes.
- Delivered unassembled for easy transportation and storage.
- It won't dent, crack, rust, chip or break.2

Ürün Kodu Code	TTA-3753
Renkler Colors	Siyah, Kahverengi, Gri, Bej Black, Brown, Grey, Beige
Dış Boyutları Ext. Dimensions	L: 870xW: 690xH: 1760 mm
Koli Boyutları Carton Size	L: 900xW: 730xH: 1830 mm
Koli İçi Adedi Quantity	1 Adet/Pcs.
Net Ağırlığı Net Weight	35 Kg
Brüt Ağırlığı Gross Weight	38 Kg



Özellikler / Features

- Hem tepsi hem tabak taşıyabilir, çok amaçlı, kullanışlı, dayanıklı ve güvenlidir.
- Gıdaya uygun, insan sağlığına zararsız polietilenden üretilmiştir. Geri dönüşümlü olduğundan çevre dostu bir üründür.
- Self servis hatları başında ve açık büfe ekipmanlarını taşımada çok kullanışlıdır.
- Gövdesi kaynaklı, monoblok ve çift cidarlı üretilerek, iç ve dış duvarlar arasında poliüretan (CFC-FREE) enjekte edilmiştir. Böylece daha fazla ağırlık altında bile görevini sorunsuz olarak yerine getirir.
- Ayarlanabilir iki ara bölümü sayesinde de değişik ebatlarda tepsi ve tabakların taşınmasında kullanılabilir.
- 2 frenli ve dönerli, 2 frensiz ve dönerli 4 adet tekerlek ile rahatça hareket ettirilebilir ve durdurulabilir.
- Paslanmaz, kırılmaz ve çatlamaz.
- Depoda saklamak ve sevkiyat için örtüsü mevcuttur.

- Suitable for stores to transport plates and trays.
- Multi-purpose, handy, substantive and reliable use.
- Made of LLDPE low density polyethylene which is suitable for food and harmless for human health, recyclable and environmentally friendly.
- Injected with CFC-free polyurethane between the internal and external walls making a double wall handling more weight to reduce noises and add strength to the structural body.
- Equipped by 2 adjustable booths to carry different dimensions of trays and dishes.
- Provides easy movement by 2 heavy-duty ϕ 15.24 mm swivel wheels and 2 casters with brakes.
- Includes vinyl cover for safe storage and hygiene

Tabak İstif Arabası Plate Stacking Trolley

Özellikler / Features

Ebatlar: 720x720x1820 mm

- 16-32 cm tabaklara ayarlanabilir.
- 60-80-120 tabak kapasiteli modelleri mevcuttur.
- Ana gövde paslanmaz profil, tabak taşıma çubukları profili alüminyumdandır.
- 125 mm frenli 4 adet tekerleklidir.
- Tabak taşıma çubukları 1,1 Kg ağırlığa kadar taşır.
- Tabak taşıma çubukları TPE'den yapılmıştır. Kaplaması, boyası kalmaz.
- Demonte olarak sevki edilir. Nakliye avantajı sağlamaktadır.

- Easily adjusted panels, suitable for all sizes of plates from ϕ 16 cm to ϕ 32 cm.
- Dishes with different diameters can be stacked on the same trolley.
- Available models: 60, 80, 120 plates trolleys.
- Plate spacing 75 cm.
- Plate holders with soft grip surface coated with thermos polyethylene.
- Loading capacity: 1.1 kg by holder pair
- The plate stacking trolley is equipped with anti-corrosion 30x30 mm stainless steel square tube profile.
- Lightweight, easy to move with ϕ 16 swivel casters.
- Dimensions: 720x720x1820 mm.

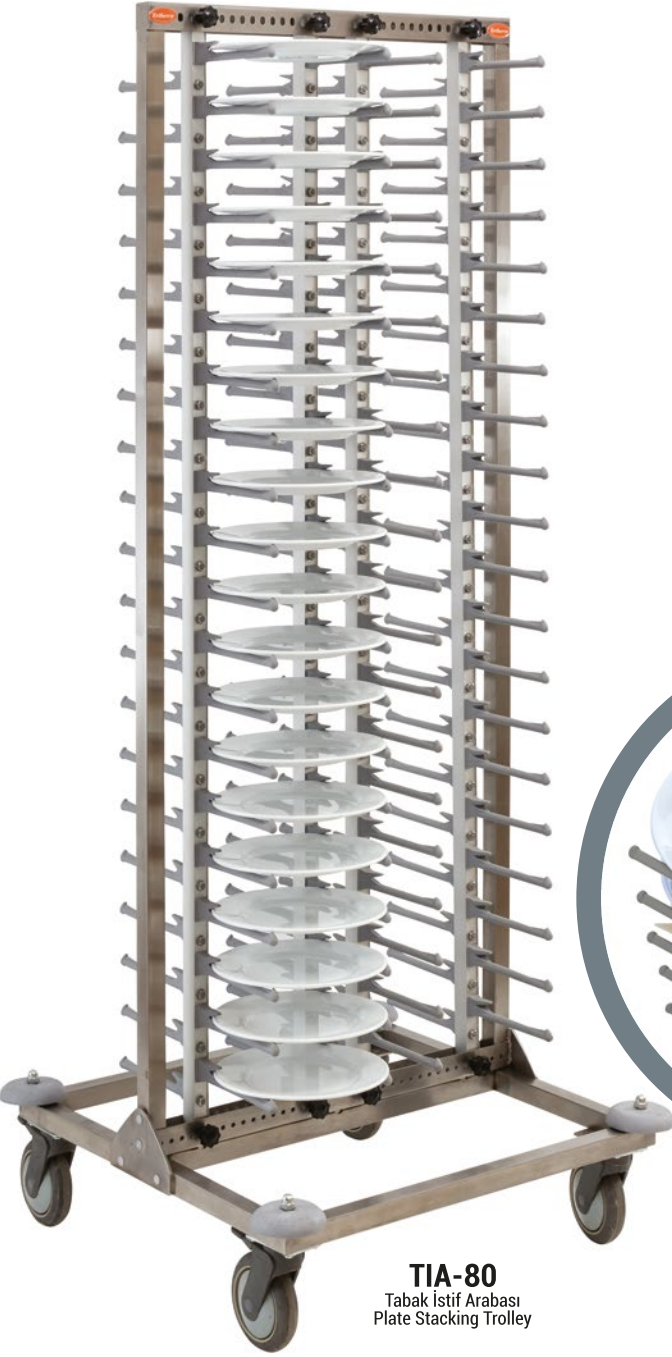

TIA-80
Tabak İstif Arabası
Plate Stacking Trolley



**Kaymaz Özel
Taşıma Çubukları
Non-slip Special
Plates Fingers**



TIS-20
Tabak İstif Set Üstü
20 Tabaklık
Plate Stacking Unit
20 Plates

Ürün Kodu Code	TIA-80	TIS-20
Renkler Colors	Gri / Grey	Gri / Grey
Dış Boyutları Ext. Dimensions	L: 720xW: 720xH: 1820 mm	L: 340xW: 460xH: 890 mm
Koli Boyutları Carton Size	L: 740xW: 740xH: 250 mm L: 675xW: 110xH: 1620 mm	L: 380xW: 480xH: 910 mm
Koli İçi Adedi Quantity	1 Adet/Pcs.	1 Adet/Pcs.
Net Ağırlığı Net Weight	24,3 Kg	5,60 Kg
Brüt Ağırlığı Gross Weight	28,8 Kg	6,90 Kg
Maks. Kapasite Max. Capacity	80 Tabak/Plates	20 Tabak/Plates

Tabak Arabaları Ayarlanabilir Dish Carts Adjustable

Özellikler / Features

- Gıdaya uygun LLDPE'den üretilmiştir.
- Gövdesi kaynaksız, monoblok ve çift cidarlı olarak üretilmiştir.
- 18-32,5 cm tabaklar için uygundur.
- 2 frenli döner, 2 frensiz sabit tekerleğe sahiptir. Her türlü yüzeyde kolayca hareket eder.
- Dayanıklı, bütün hava şartlarına uygun polietilen yüzeyi çatlamaz, içe göçmez, şişmez, paslanmaz, sızdırmaz ve kırılmaz.
- Uzun ömürlüdür.
- Bölme başına tabak taşıma kapasitesi 45-60 tabak arasındadır.
- Tabaklara kolay erişim için açık bölmeli tasarlanmıştır.
- Her iki uçta kırılma, kopma yapmayan kalıba monte monobloklu tutacaklar vardır.
- Kolayca temizlenebilir.
- Ayarlanabilir bölmeler sayesinde çeşitli ebatlardaki tabaklar emniyetli ve güvenli bir şekilde taşınabilir.
- Tabakların sabit bir biçimde durmasını sağlamak için yeri değiştirilebilen bölümleyiciler kolayca ayarlanabilir.
- Sevkiyat ve depolama için örtüsü mevcuttur.

- Made of low density polyethylene. Monobloc construction for a long-term usage.
- Includes 6 pcs polyethylene molded adjustable dividers that help change the size of the column based on the size of the dish.
- Safe storage and carriage.
- High movement capability thanks to heavy duty wheels and swivel brakes.
- Stores 45 to 60 dishes for each shelf.
- Open shelf design for easy.
- Break-proof monobloc construction that provides easy holding.
- Easy cleaning
- Adjustable model provides reliable and safe transportation.
- Integrated metal parts that help plates be in a fixed position.
- Environmentally friendly and recyclable.
- It won't dent, crack, rust, chip or break.
- Includes vinyl cover for safe storage and hygiene
It doesn't require mounting/assembly



TAA-4
730x730x820 mm



TAA-6
1100x710x800 mm



TAA-6B
985x760x900 mm
with 5 Casters

Ürün Kodu Code	TAA-4	TAA-6	TAA-6B
Renkler Colors	Siyah / Black	Siyah, Kahverengi Black, Brown	Siyah, Kahverengi Black, Brown
Boyutları Dimensions	L: 730xW: 730xH: 815 mm	L: 1100xW: 710xH: 800 mm	L: 985xW: 760xH: 900 mm
Koli Boyutları Carton Size	L: 740xW: 735xH: 820 mm	L: 1110xW: 730xH: 815 mm	L: 1000xW: 780xH: 920 mm
Koli İçi Adedi Quantity	1 Adet/Pcs.	1 Adet/Pcs.	1 Adet/Pcs.
Net Ağırlığı Net Weight	27,90 Kg	37,50 Kg	37 Kg
Brüt Ağırlığı Gross Weight	31,40 Kg	41,60 Kg	40 Kg
Maks. Kapasite Max. Capacity	180-400 Tabak/Plates	180-480 Tabak/Plates	180-480 Tabak/Plates

TAA-4

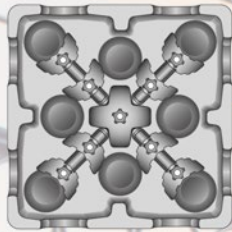

14 cm Plates

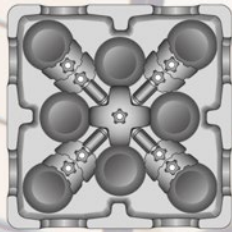

16,50 cm Plates

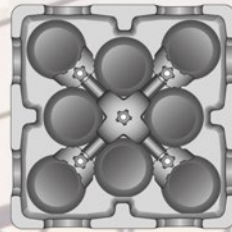

15-19 cm Plates

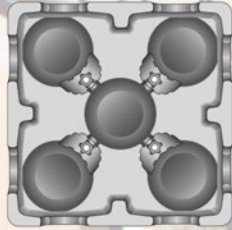

23 cm Plates

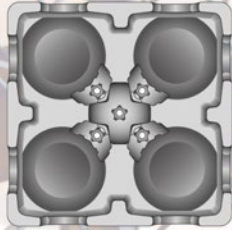

21-28 cm Plates

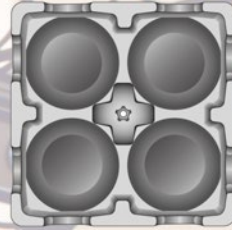

30,50 cm Plates

TAA-6



25-38,50 cm Plates

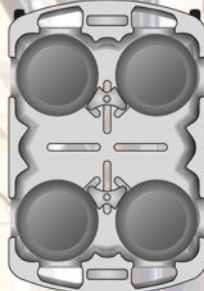

31-34 cm Plates



22-30,50 cm Plates

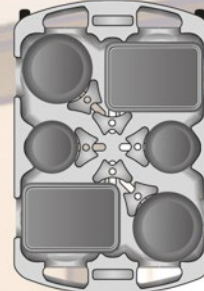

19-25 cm Plates

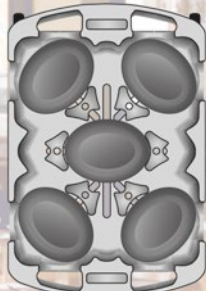

23-30,50 cm Plates



21-25 cm Plates



20-21 cm Plates

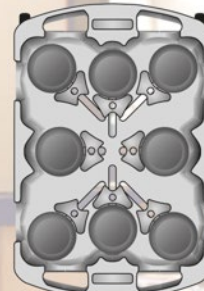

20 cm Plates

TAA-6B

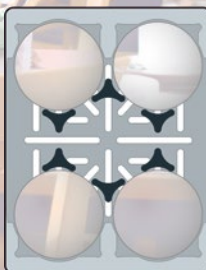

11-33 cm Plates

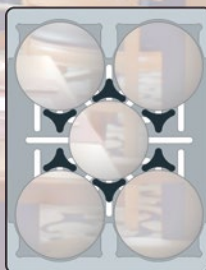

11-33 cm & 17,5-30 cm Plates

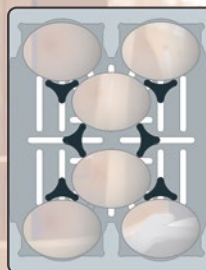

20-29 cm & 13-22 cm Oval Plates



25-29 cm Square Plates

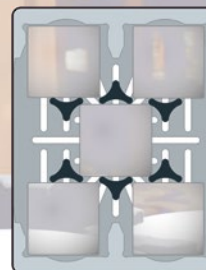

24-28 cm Square Plates

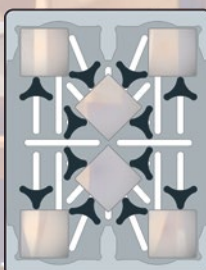

15-20 cm Round & Square Plates



22-29 cm Oval Plates & 40 cm Round Tray

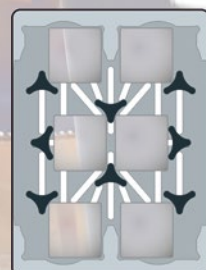

20 cm Square Plates

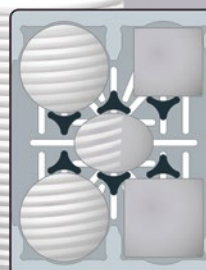

33,50 cm Round Plates + 25 and 29 cm Square + 21-29 cm Oval Plates

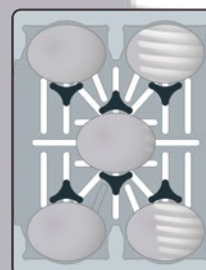

22-29 cm Oval Plates

Buz Konteyneri İzolasyonlu Insulation Ice Bin Cart



Özellikler / Features

- Gıdaya uygun polietilen ve poliüretandan (CFC-FREE) yapılmıştır.
- Gövdesi kaynaklı, monoblok ve çift cidarlı olarak üretilmiştir.
- 2 adet dönerli frenli ve 2 adet sabit tekerlekler sayesinde doluyken bile kolay hareket edebilir.
- Polietilen gövde ve kalın poliüretan köpük ile sağlanan yalıtım sayesinde günlerce buz saklanabilir.
- Dayanıklı, bütün hava şartlarına uygun dış yüzeyi çatlamaz, içe geçmez, şişmez, paslanmaz, sızdırmaz ve kırılmaz.
- Montaj gerektirmez.
- Korunaklı musluğu ve su boşaltma haznesi sayesinde suyu buzdan ayrı tutarak buz daha uzun süre eritmeden tutar.
- Kayar kapağı çapraz bulaşma (HACCP) riskini azaltır.
- Kolayca temizlenebilir.
- Uzun süreli beklemeelerde içeride biriken suyu musluktan tahliye etmek faydalı olur.

- Made of food grade CFC-FREE polyethylene and polyurethane.
- Double walled seamless body with monobloc construction.
- Equipped with 2 swivel wheels with brakes and 2 fixed without brakes.
- Due to its polyethylene structure and polyurethane foam insulation, ice can be kept in it for days.
- Durable and suitable for all weather conditions. Its body doesn't break, crackle, chip or dent.
- It doesn't require mounting/assembly.
- Its sheltered tap and ice water discharge chamber allow ice to be kept a long time without melting.
- Slide opening lid that reduces the risk of cross contamination.
- Easy to clean.
- It is useful to drain the accumulated water from the tap during long waiting periods.

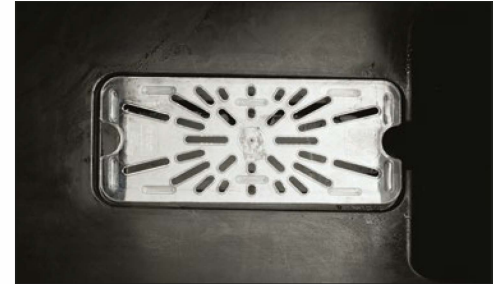

Ürün Kodu Code	BK-125	BK-175
Renkler Colors	Siyah, Kahverengi Black, Brown	Siyah, Kahverengi Black, Brown
Boyutları Dimensions	L: 610xW: 800xH: 745 mm	L: 610xW: 965xH: 745 mm
Koli Boyutları Carton Size	L: 620xW: 810xH: 760 mm	L: 645xW: 970xH: 760 mm
Koli İçi Adedi Quantity	1 Adet/Pcs.	1 Adet/Pcs.
Net Ağırlığı Net Weight	28,10 Kg	29,40 Kg
Brüt Ağırlığı Gross Weight	30,70 Kg	32,40 Kg
Maks. Kapasite Max. Capacity	125 L (57 Kg)	175 L (80 Kg)

Un ve Şeker Arabası Ingredient Bin



USA-102
102 L

Ürün Kodu Code	USA-102
Renkler Colors	Beyaz / White
Boyutları Dimensions	L: 420xW: 750xH: 710 mm
Koli Boyutları Carton Size	L: 430xW: 770xH: 1190 mm
Koli İçi Adedi Quantity	3 Adet/Pcs.
Net Ağırlığı Net Weight	26,40 Kg
Brüt Ağırlığı Gross Weight	28,50 Kg
Maks. Kapasite Max. Capacity	102 L

Özellikler / Features

- Standart çalışma tezgahları altına girebilecek şekilde tasarlanmıştır.
- Gövdesi gıdaya uygun polietilenden (PE) üretildiği için astar kullanmaya gerek yoktur.
- Şeffaf kapaklar gıdaya uygun polikarbonattan üretilmiştir. Bu sayede kutunun içinde ne olduğu kapak açılmadan görülebilir.
- Pürüzsüz iç ve dış yüzeyler kolayca temizlenebilir.
- 80x32 mm 2 adet dönerli ve 80x32 mm 2 adet sabit tekerleklidir.
- Geniş Tabanlı tekerleri sayesinde mükemmel bir denge ve yük dayanımı sağlar.
- Un veya tahıl gibi yüksek miktarlarda kullanılan kuru gıdaları saklar.
- Hareketli olması verimliliğini artırır ve zaman kaybını azaltır.
- Kolayca temizlenebilir.
- Darbelerde esnek ve dayanıklı gövdesi sayesinde ezilmez, kırılmaz ve çökmez.

- Designed to fit under standard work tables.
- Bin made of LLDPE suitable for food. No liners needed.
- Transparent lids made of polycarbonate providing visibility without opening the covers.
- High efficiency for the storage of flour, sugar, rice and grains, etc.
- Smooth interior and exterior surfaces that can be easily cleaned.
- 2 pcs 80x32 mm swivel wheels and 2 pcs 80x32 mm fixed covers.
- Preserves dry food.
- Environmentally friendly and recyclable.
- It won't dent, crack, rust, chip or break.



Bebe Mama Sandalyesi Baby Chair



BMS-86
Monoblok / Monoblock

Özellikler / Features

- Hafif ve rahattır.
- Monoblok gövdesi sayesinde uzun ömürlü ve dayanıklıdır.
- Monoblok mama sandalyesi (BMS-86) gıdaya uygun polietilenden üretilmiştir.
- Çocuğunuz için herhangi bir sağlık riski taşımaz.
- Kullanımı kolaydır, rahatça standart masalara yanıştırılabilir.
- Oyuk içine yerleştirilmiş tekerlekleri sayesinde istemdişi kaymaz.
- Çocukların sandalyeden düşmesini engellemek amaçlı emniyet kemeri vardır.
- Restoranlar, kreşler ve kafeteryalar için oldukça kullanışlıdır.
- Kolayca temizlenebilir.

- Light and comfortable.
- Monobloc construction for long term usage and impact resistance.
- Made of polypropylene suitable for food and harmless for children.
- Easy to move.
- Thanks to integrated sockets, it won't slide voluntarily.
- Ideal for restaurants, cafés and kindergartens.
- Its wide pan makes feeding the baby more comfortable.
- Easy to clean.
- It won't dent, crack, rust, chip or break.

Ürün Kodu Code	BMS-86 (Monoblok 2 Tekerli Monoblock, 2 Wheeled)
Renkler Colors	Gri / Grey
Boyutları Dimensions	L: 500xW: 590xH: 860 mm
Koli Boyutları Carton Size	L: 525xW: 610xH: 865 mm
Koli İçi Adedi Quantity	1 Adet/Pcs.
Net Ağırlığı Net Weight	8,10 Kg
Brüt Ağırlığı Gross Weight	10,40 Kg



Bebe Altı Deęiřtirme Ünitesi Baby Changing Station

27

Özellikler / Features

- Duvara monte edilebilir.
 - Geniř ve derin bebek yatıtımına sahiptir.
 - Özel hidrolik sistemi sayesinde duvarda kapaęı kapalı vaziyette durur ve yer tasarrufu saęlar.
 - Ebeveynlerin çanta ve benzeri eřyalara asabilmesi için askı bölümü vardır.
 - Bebek güvenlięi için emniyet kemeri bulunmaktadır.
 - Ürün antibakteriyel olup alerji yapmaz.
 - Ön etiket bölümü firma logosu, marka gibi reklam alanı olarak kullanılabilir.
- Wall mounted
 - Has a wide and deep laying space for the baby.
 - Thanks to its hydraulic system, its cover can be closed on the wall saving the space in the room.
 - It includes a hanging part. Parents can hang in it their bags and similar items.
 - Includes safety belt for the baby.
 - The product is antibacterial and absolutely harmless for babies not causing any allergies.
 - Label space that can be used to advertise companies or brands.

Usage Areas

Has been designed to be used at restroom and bathroom of the public restrooms, shopping malls, health and industry associations, petrol stations, cafes and restaurants etc.



BAD-01

Ürün Kodu Code	BAD-01
Renkler Colors	Gri, Bej Grey, Beige
Boyutları Dimensions	L: 500xW: 860xH: 80 mm
Koli Boyutları Carton Size	L: 530xW: 880xH: 120 mm
Koli İçi Adedi Quantity	1 Adet/Pcs.
Net Aęırlığı Net Weight	7,90 Kg
Brüt Aęırlığı Gross Weight	8,40 Kg

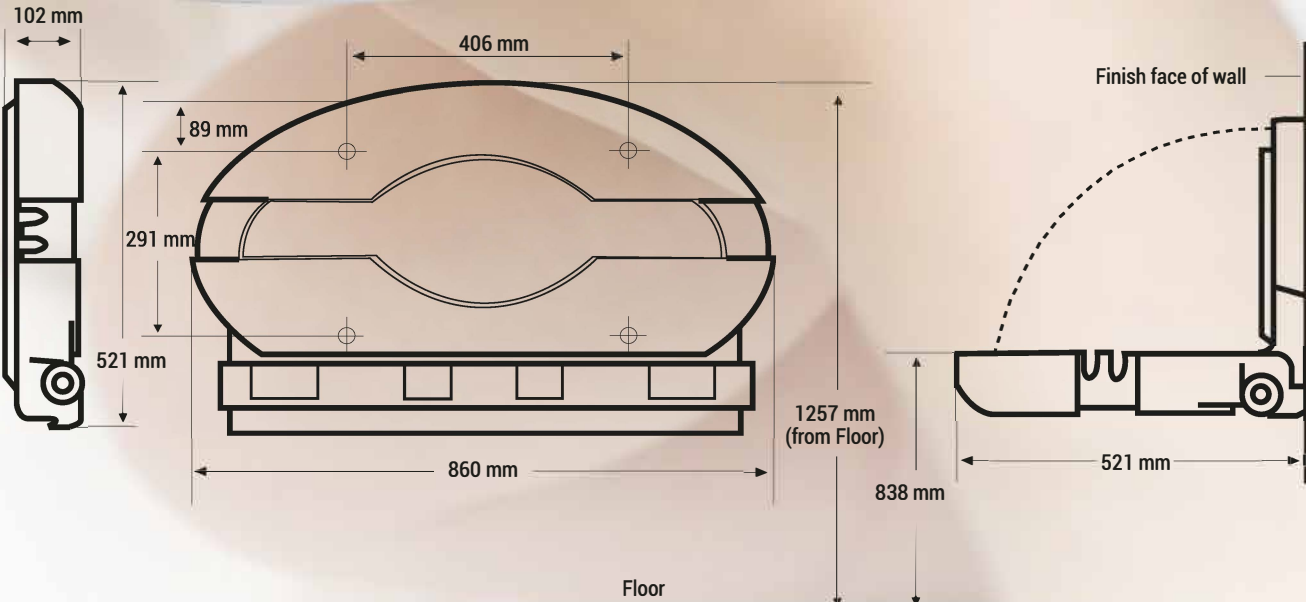

Bulaşık Makinesi Basketleri Dishwasher Racks & Extenders



**Tabak Basketi
Plate Rack**

TB-50

Renk/Color	Mavi/Blue
Ölçüler/Dimension	L500xW500xH100 mm
Kutu Ölçüsü/Carton Size	L515xW515xH595 mm
Adet/Quantity	6 Adet/Pcs.
Net Ağırlık/Net Weight	10,20 Kg
Brüt Ağırlık/Gross Weight	11,10 Kg



**Çatal Kaşık Basketi
Regular Cutlery Rack**

CKB-50

Renk/Color	Mavi/Blue
Ölçüler/Dimension	L500xW500xH100 mm
Kutu Ölçüsü/Carton Size	L515xW515xH595 mm
Adet/Quantity	6 Adet/Pcs.
Net Ağırlık/Net Weight	8 Kg
Brüt Ağırlık/Gross Weight	9 Kg



**Düz Bardak Basketi
Regular Glass Rack**

DBB-50

Renk/Color	Mavi/Blue
Ölçüler/Dimension	L500xW500xH100 mm
Kutu Ölçüsü/Carton Size	L515xW515xH595 mm
Adet/Quantity	6 Adet/Pcs.
Net Ağırlık/Net Weight	8,70 Kg
Brüt Ağırlık/Gross Weight	9,60 Kg

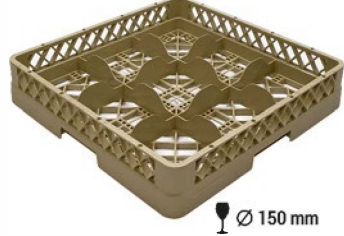

**9 Bölmeli Bardak Basketi
9 Compartment Glass Rack**

BB-9

Renk/Color	Bej/Beige
Ölçüler/Dimension	L500xW500xH100 mm
Kutu Ölçüsü/Carton Size	L515xW515xH595 mm
Adet/Quantity	6 Adet/Pcs.
Net Ağırlık/Net Weight	8,700 Kg
Brüt Ağırlık/Gross Weight	9,600 Kg



**16 Bölmeli Bardak Basketi
16 Compartment Glass Rack**

BB-16

Renk/Color	Gri/Grey
Ölçüler/Dimension	L500xW500xH100 mm
Kutu Ölçüsü/Carton Size	L515xW515xH595 mm
Adet/Quantity	6 Adet/Pcs.
Net Ağırlık/Net Weight	9,60 Kg
Brüt Ağırlık/Gross Weight	10,50 Kg

Ø 113 mm



**25 Bölmeli Bardak Basketi
58 Compartment Glass Rack**

BB-16

Renk/Color	Mavi/Blue
Ölçüler/Dimension	L500xW500xH100 mm
Kutu Ölçüsü/Carton Size	L515xW515xH595 mm
Adet/Quantity	6 Adet/Pcs.
Net Ağırlık/Net Weight	10,800 Kg
Brüt Ağırlık/Gross Weight	11,700 Kg

Ø 90 mm



**36 Bölmeli Bardak Basketi
36 Compartment Glass Rack**

BB-36

Renk/Color	Yeşil/Green
Ölçüler/Dimension	L500xW500xH100 mm
Kutu Ölçüsü/Carton Size	L515xW515xH595 mm
Adet/Quantity	6 Adet/Pcs.
Net Ağırlık/Net Weight	11,400 Kg
Brüt Ağırlık/Gross Weight	12,300 Kg

Ø 74 mm



**49 Bölmeli Bardak Basketi
49 Compartment Glass Rack**

BB-49

Renk/Color	Kırmızı/Red
Ölçüler/Dimension	L500xW500xH100 mm
Kutu Ölçüsü/Carton Size	L515xW515xH595 mm
Adet/Quantity	6 Adet/Pcs.
Net Ağırlık/Net Weight	12,900 Kg
Brüt Ağırlık/Gross Weight	13,800 Kg

Ø 63 mm

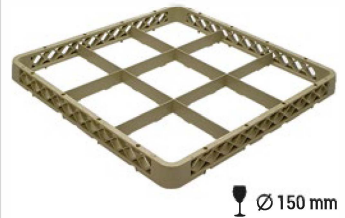

**9 Bölmeli Yükseltici
9 Compartment Extender**

BY-9

Renk/Color	Bej/Beige
Ölçüler/Dimension	L500xW500xH40 mm
Kutu Ölçüsü/Carton Size	L515xW515xH295 mm
Adet/Quantity	6 Adet/Pcs.
Net Ağırlık/Net Weight	3,300 Kg
Brüt Ağırlık/Gross Weight	4 Kg

Ø 150 mm



**16 Bölmeli Yükseltici
16 Compartment Extender**

BY-16

Renk/Color	Gri/Grey
Ölçüler/Dimension	L500xW500xH40 mm
Kutu Ölçüsü/Carton Size	L515xW515xH295 mm
Adet/Quantity	6 Adet/Pcs.
Net Ağırlık/Net Weight	3,600 Kg
Brüt Ağırlık/Gross Weight	4,300 Kg

Ø 113 mm

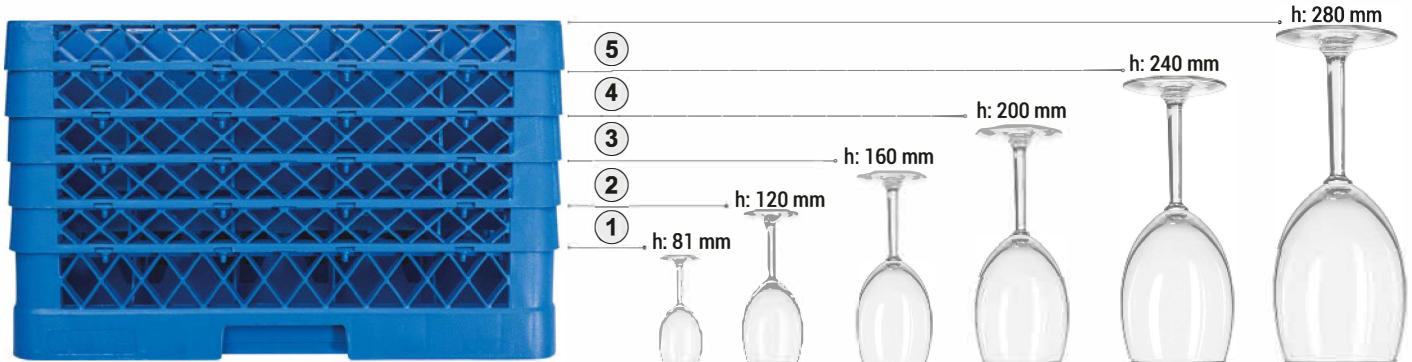



25 Bölmeli Yükseltici 25 Compartment Extender

BY-25

Renk/Color	Mavi/Blue
Ölçüler/Dimension	L500xW500xH40 mm
Kutu Ölçüsü/Carton Size	L515xW515xH295 mm
Adet/Quantity	6 Adet/Pcs.
Net Ağırlık/Net Weight	4 Kg
Brüt Ağırlık/Gross Weight	4,700 Kg

Ø 90 mm



36 Bölmeli Yükseltici 36 Compartment Extender

BY-36

Renk/Color	Yeşil/Green
Ölçüler/Dimension	L500xW500xH40 mm
Kutu Ölçüsü/Carton Size	L515xW515xH295 mm
Adet/Quantity	6 Adet/Pcs.
Net Ağırlık/Net Weight	4,900 Kg
Brüt Ağırlık/Gross Weight	5,500 Kg

Ø 74 mm



49 Bölmeli Yükseltici 49 Compartment Extender

BY-49

Renk/Color	Kırmızı/Red
Ölçüler/Dimension	L500xW500xH40 mm
Kutu Ölçüsü/Carton Size	L515xW515xH295 mm
Adet/Quantity	6 Adet/Pcs.
Net Ağırlık/Net Weight	5,400 Kg
Brüt Ağırlık/Gross Weight	6 Kg

Ø 63 mm



Açık Bölmesiz Yükseltici Open Extender

AY-50

Renk/Color	Mavi/Blue
Ölçüler/Dimension	L500xW500xH40 mm
Kutu Ölçüsü/Carton Size	L515xW515xH295 mm
Adet/Quantity	6 Adet/Pcs.
Net Ağırlık/Net Weight	2,400 Kg
Brüt Ağırlık/Gross Weight	3,100 Kg



35x35 Bardak Basketi 35x35 Glass Rack

BMS-35

Renk/Color	Gri/Grey
Ölçüler/Dimension	L350xW350xH150 mm
Kutu Ölçüsü/Carton Size	L515xW515xH595 mm
Adet/Quantity	6 Adet/Pcs.
Net Ağırlık/Net Weight	3,900 Kg
Brüt Ağırlık/Gross Weight	4,700 Kg



Tepsi Basketi Tray Rack

TP-50

Renk/Color	Bej/Beige
Ölçüler/Dimension	L500xW500xH40 mm
Kutu Ölçüsü/Carton Size	L515xW515xH295 mm
Adet/Quantity	6 Adet/Pcs.
Net Ağırlık/Net Weight	9,600 Kg
Brüt Ağırlık/Gross Weight	10,600 Kg



Tabak Yıkama Aparatı Rack for 12 Plates

TYA-35

Renk/Color	Gri/Grey
Ölçüler/Dimension	L292xW90xH75 mm
Kutu Ölçüsü/Carton Size	L515xW515xH295 mm
Adet/Quantity	40 Adet/Pcs.
Net Ağırlık/Net Weight	5,750 Kg
Brüt Ağırlık/Gross Weight	6,600 Kg



Çatal Kaşık Basketi 8 Bölmeli 8 Compartment Cutlery Rack

CKB-8

Renk/Color	Gri/Grey
Ölçüler/Dimension	L450xW193xH184 mm
Kutu Ölçüsü/Carton Size	L515xW515xH295 mm
Adet/Quantity	6 Adet/Pcs.
Net Ağırlık/Net Weight	7,200 Kg
Brüt Ağırlık/Gross Weight	8,200 Kg



Çatal Kaşık Yıkama Aparatı Round Basket for Cutlery

CKA-35

Renk/Color	Gri/Grey
Ölçüler/Dimension	Ø 110 H. 125 mm
Kutu Ölçüsü/Carton Size	L515xW515xH295 mm
Adet/Quantity	40 Adet/Pcs.
Net Ağırlık/Net Weight	2,300 Kg
Brüt Ağırlık/Gross Weight	3,150 Kg



Çatal Kaşık 4 Gözlü Cutlery Dispenser 4 Compartment

KVR-4

Renk/Color	Gri/Grey
Ölçüler/Dimension	L540xW33,0xH100 mm
Kutu Ölçüsü/Carton Size	L515xW515xH295 mm
Adet/Quantity	24 Adet/Pcs.
Net Ağırlık/Net Weight	15,600 Kg
Brüt Ağırlık/Gross Weight	17,400 Kg



Bulaşık Makinesi Basketleri (Yeni Model)

Dishwasher Racks & Extenders (New Model)



CARTON SIZE: L: 510 mm W: 510 mm H: 700 mm

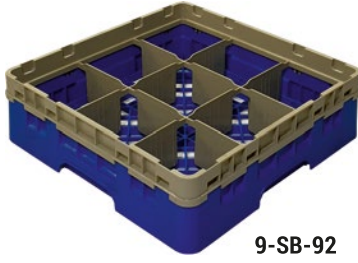

9-SB-92

Kod Code	Açıklama Description	Maks. Bardak Yüksekliği Max Glass Heigh	Koli Adedi Case Pack
9-SB-92	9 Comp.Glass Rack	max. h: 92 mm Glass	5
9-SB-133	9 Comp.Glass Rack	max. h: 133 mm Glass	4
9-SB-174	9 Comp.Glass Rack	max. h: 174 mm Glass	3
9-SB-215	9 Comp.Glass Rack	max. h: 215 mm Glass	2
9-SB-257	9 Comp.Glass Rack	max. h: 257 mm Glass	2
9-SB-298	9 Comp.Glass Rack	max. h: 298 mm Glass	2

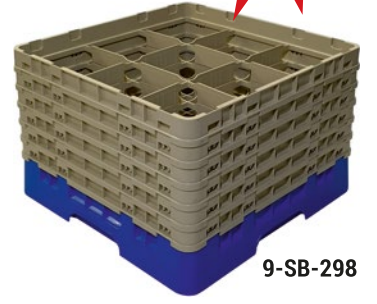

9-SB-298

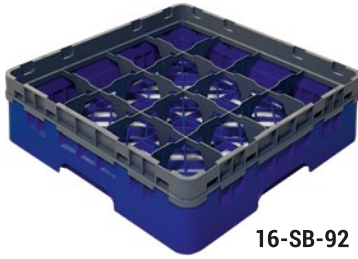

16-SB-92

16-SB-92	16 Comp.Glass Rack	max. h: 92 mm Glass	5
16-SB-114 *	16 Comp.Glass Rack	max. h: 114 mm Glass	5
16-SB-133	16 Comp.Glass Rack	max. h: 133 mm Glass	4
16-SB-155 *	16 Comp.Glass Rack	max. h: 155 mm Glass	4
16-SB-174	16 Comp.Glass Rack	max. h: 174 mm Glass	3
16-SB-196 *	16 Comp.Glass Rack	max. h: 196 mm Glass	3
16-SB-215	16 Comp.Glass Rack	max. h: 215 mm Glass	2
16-SB-238 *	16 Comp.Glass Rack	max. h: 238 mm Glass	2
16-SB-257	16 Comp.Glass Rack	max. h: 257 mm Glass	2
16-SB-279 *	16 Comp.Glass Rack	max. h: 279 mm Glass	2
16-SB-298	16 Comp.Glass Rack	max. h: 298 mm Glass	2
16-SB-320 *	16 Comp.Glass Rack	max. h: 320 mm Glass	2



16-SB-320

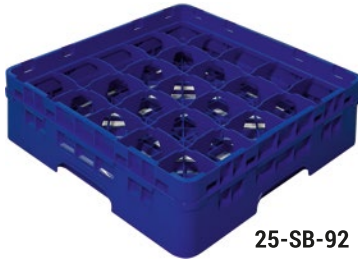

25-SB-92

25-SB-92	25 Comp.Glass Rack	max. h: 92 mm glass	5
25-SB-114 *	25 Comp.Glass Rack	max. h: 114 mm glass	5
25-SB-133	25 Comp.Glass Rack	max. h: 133 mm glass	4
25-SB-155 *	25 Comp.Glass Rack	max. h: 155 mm glass	4
25-SB-174	25 Comp.Glass Rack	max. h: 174 mm glass	3
25-SB-196 *	25 Comp.Glass Rack	max. h: 196 mm glass	3
25-SB-215	25 Comp.Glass Rack	max. h: 215 mm glass	2
25-SB-238 *	25 Comp.Glass Rack	max. h: 238 mm glass	2
25-SB-257	25 Comp.Glass Rack	max. h: 257 mm glass	2
25-SB-279 *	25 Comp.Glass Rack	max. h: 279 mm glass	2
25-SB-298	25 Comp.Glass Rack	max. h: 298 mm glass	2
25-SB-320 *	25 Comp.Glass Rack	max. h: 320 mm glass	2

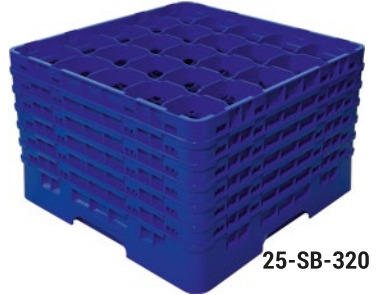

25-SB-320

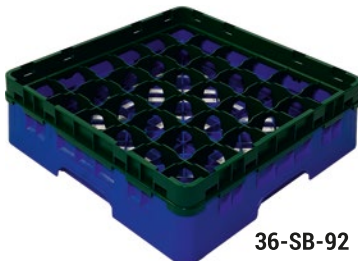

36-SB-92

36-SB-92	36 Comp.Glass Rack	Max. h: 92 mm Glass	5
36-SB-114 *	36 Comp.Glass Rack	Max. h: 114 mm Glass	5
36-SB-133	36 Comp.Glass Rack	Max. h: 133 mm Glass	4
36-SB-155 *	36 Comp.Glass Rack	Max. h: 155 mm Glass	4
36-SB-174	36 Comp.Glass Rack	Max. h: 174 mm Glass	3
36-SB-196 *	36 Comp.Glass Rack	Max. h: 196 mm Glass	3
36-SB-215	36 Comp.Glass Rack	Max. h: 215 mm Glass	2
36-SB-238 *	36 Comp.Glass Rack	Max. h: 238 mm Glass	2
36-SB-257	36 Comp.Glass Rack	Max. h: 257 mm Glass	2
36-SB-279 *	36 Comp.Glass Rack	Max. h: 279 mm Glass	2
36-SB-298	36 Comp.Glass Rack	Max. h: 298 mm Glass	2
36-SB-320 *	36 Comp.Glass Rack	Max. h: 320 mm Glass	2

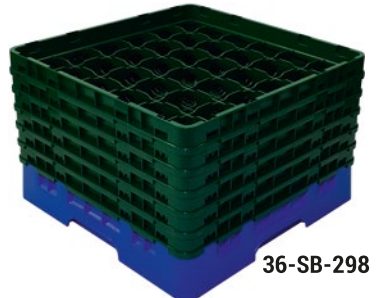

36-SB-298

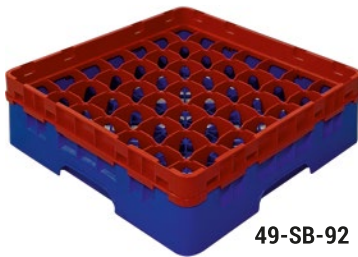

49-SB-92

49-SB-92	49 Comp.Glass Rack	Max. h: 92 mm Glass	5
4-SB-133	49 Comp.Glass Rack	Max. h: 133 mm Glass	4
49-SB-174	49 Comp.Glass Rack	Max. h: 174 mm Glass	3
49-SB-215	49 Comp.Glass Rack	Max. h: 215 mm Glass	2
49-SB-257	49 Comp.Glass Rack	Max. h: 257 mm Glass	2
49-SB-298	49 Comp.Glass Rack	Max. h: 298 mm Glass	2

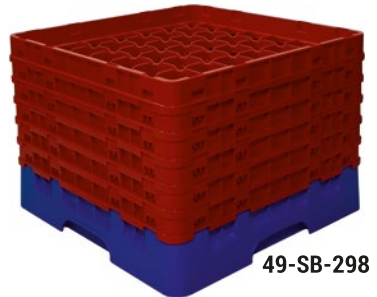

49-SB-298

* İşaretili ürünler kadehler için önerilir.
ve ilave yükseltici eklenemez.

* Marked products used for stemware.
Compartment Extenders cannot be added



Bulaşık Makinesi Basketleri (Yeni Model) Dishwasher Racks & Extenders (New Model)

EXTENDERS CARTON SIZE: L: 510 mm W: 510 mm H: 700 mm



9Y1

Kod Code	Açıklama Description	Koli Adedi Case Pack
9Y1	9 Comp. Full Drop Extender	12
16Y1	16 Comp. Full Drop Extender	12
25Y1	25 Comp. Full Drop Extender	12
36Y1	36 Comp. Full Drop Extender	12
49Y1	49 Comp. Full Drop Extender	12

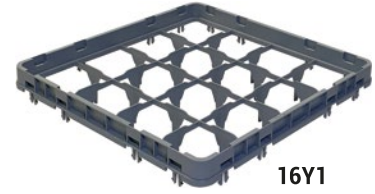

16Y1

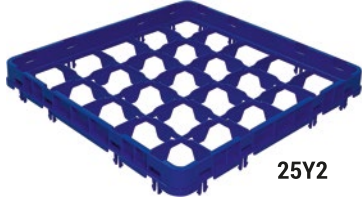

25Y2

9Y2	9 Comp. Half Drop Extender	12
16Y2	16 Comp. Half Drop Extender	12
25Y2	25 Comp. Half Drop Extender	12
36Y2	36 Comp. Half Drop Extender	12
49Y2	49 Comp. Half Drop Extender	12

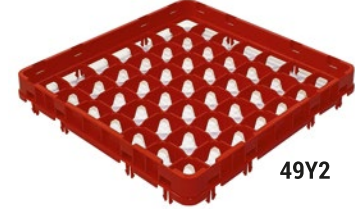

49Y2



16Y4

16Y4	16 Comp. Full Drop Stemware Extender	12
25Y4	25 Comp. Full Drop Stemware Extender	12
36Y4	36 Comp. Full Drop Stemware Extender	12

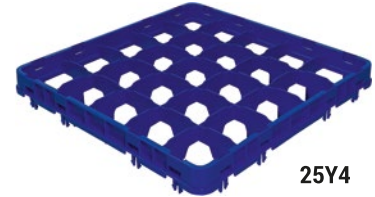

25Y4

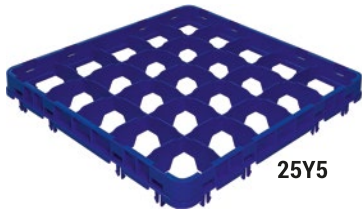

25Y5

16Y5	16 Comp. Half Drop Stemware Extender	12
25Y5	25 Comp. Half Drop Stemware Extender	12
36Y5	36 Comp. Half Drop Stemware Extender	12

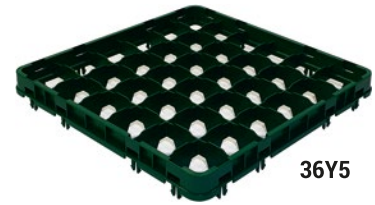

36Y5

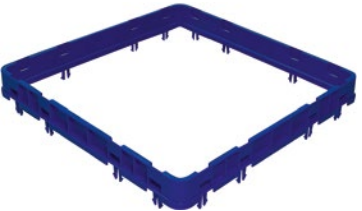

SY-3	Open Extender	12
------	---------------	----



SKK-50	Rack Cover for Full Size	Grey	500x500x24 mm
--------	--------------------------	------	---------------

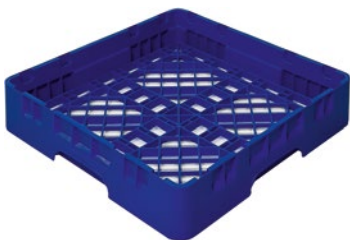

Code	: SDB-50
Product	: Regular Glass Rack
Color	: Blue
Dimensions (mm)	: 500x500x101 mm
Carton Size (6 pcs)	: 510x510x580 mm
Net Kg	: 8,300 kg
Gross Kg	: 9,300 kg

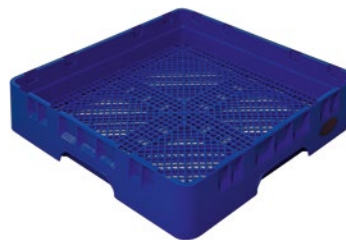

Code	: SCK-50
Product	: Regular Cutlery Rack
Color	: Blue
Dimensions (mm)	: 500x500x101 mm
Carton Size (6 pcs)	: 510x510x580 mm
Net Kg	: 10,320 kg
Gross Kg	: 11,320 kg



BO 2002



BO 2008



BO 2000



BO 2003

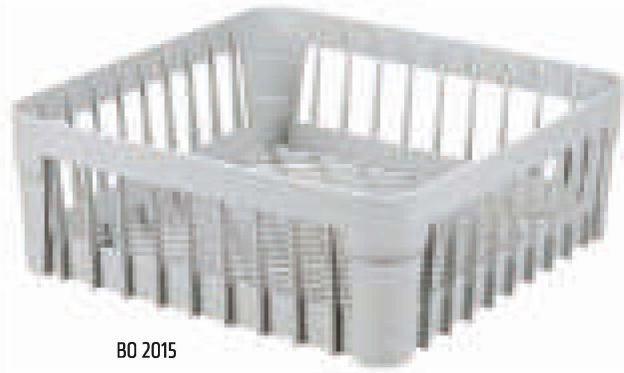

BO 2015

Gastronorm Ürünler Gastronorm Products

Kod/Code	Ebat/Size/mm	Koli içi adedi/ Pcs. in a box
BO 211	214x415x150 H	15
BO 2000	500x500x100 H	6
BO 2001	500x500x75 H	10
BO 2002	500x500x100 H	6
BO 2003	500x500x100 H	6
BO 2004	500x500x125 H	10
BO 2005	500x500x125 H	10
BO 2006	500x500x125 H	10
BO 2007	500x500x125 H	10
BO 2008	500x500x100 H	6
BO 2010	500x500x40H	15
BO 2015	400x400x150 H.	8
BO 2016	Ø 106x125 H.	24





BO 2004

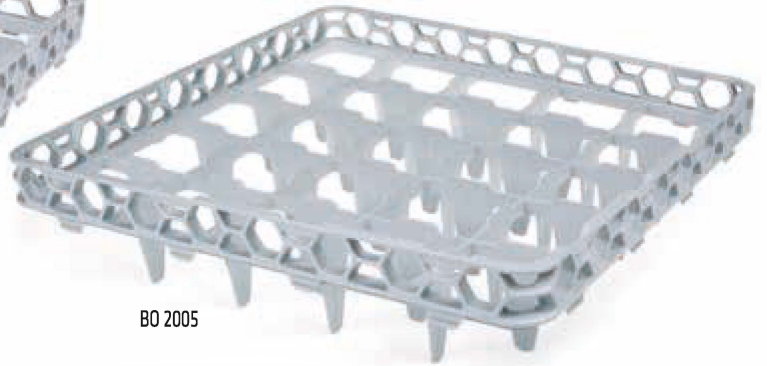

BO 2005



BO 2010



BO 2001

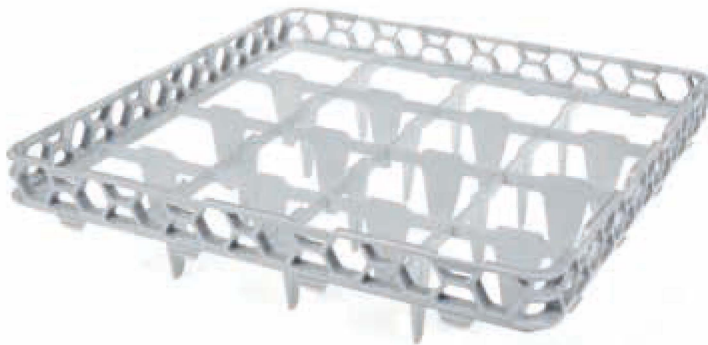

BO 2006

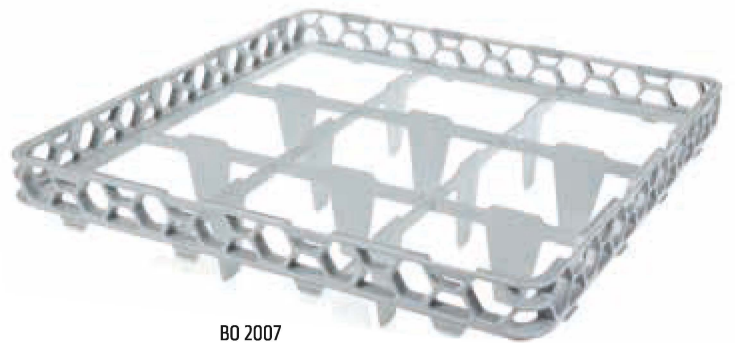

BO 2007

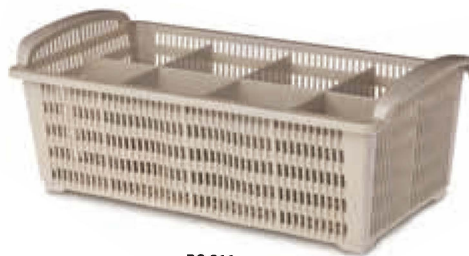

BO 211

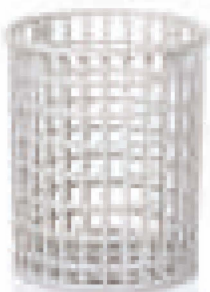

BO 2016



Blue



Grey



Beige



Red



Green



Yellow

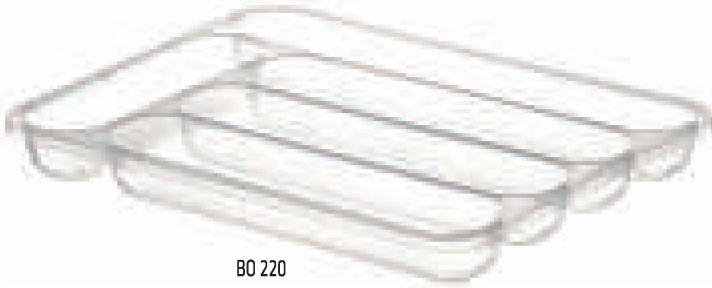

BO 220



BO 212



BO 218



BO 213



BO 215



BO 221

Kaşıklıklar • Cutlery Racks

Kod/Code	Ebat/Size/mm	No	Koliçadedi / Pcs. in a box
BO 212	175x265x33 H	1	36
BO 213	230x305x36 H	2	36
BO 215	225x140x125 H	-	36
BO 220	265x345x40 H	1	36
BO 221	345x390x47 H	4	24
BO 222	365x410x49 H	5	24
BO 218	400x305x70 H	3	14



BO 222



BO 070



BO 068



BO 069

Tabaklıklar • Washing Up Racks

Kod/Code	Ebat/Size/mm	No	Kalıçı adedi Pcs. in a box
BO 068	270x450x90 H	1	16
BO 069	300x370x85 H	2	18
BO 070	385x460x95 H	1	12



BR 1069



BR 1070



BR 1073

Metal Tabaklık • Chrome Plated Dish Drainers

Kod/Code	Ebat/Size/mm	Kaliği/adedi Pcs. in a box
BR 1069	310x485x90 H	6
BR 1070	310x485x90 H	6
BR 1073	310x475x310 H	8

Basket Taşıma Arabası Cart for Rack



BTA-01



BTA-01



BTA-02



BTA-02

Özellikler / Features

- Gövdesi kaynaksız, monoblok olarak üretilmiştir. Böylece daha fazla ağırlık altında bile görevini sorunsuz olarak yerine getirir.
- 4 adet frensiz dönen tekerlek ile rahatça hareket ettirilebilir.
- Uzun ömürlü ve dayanıklıdır.
- Kolay temizlenebilir.
- Kırılmaz ve çatlamaz.
- Basket taşıma arabasına isteğe göre, 304 kalite paslanmaz çelikten yapılmış itme kolluk takılabilir.
- Basketten çıkabilecek suları haznesinde tutar ve etrafa su sızdırmaz.
- Tekerlekler üretim sırasında gövdeye konulmuş özel somunlara montajlıdır. Çok dayanıklıdır.

- Seamless double walled monobloc construction ensuring that the products resist heavy weight
- Easy to move thanks to 4 wheels without brake.
- Durable and long lasting.
- Easy to clean
- It won't dent, crack, rust, chip or break.
- 304 AISI stainless steel handle bar (Optional)
- It keeps the water that might get out of racks in its water chamber without letting it out in the sides.
- Stainless steel bar not included (BTA-01).
- Stainless steel bar included (BTA-02).
- Body made of LLDPE.



Ürün Kodu Code	BTA-01	BTA-02 (İtme Kollu / With Handle)
Renkler Colors	Siyah, Black	Siyah, Black
Boyutları Dimensions	L: 580xW: 580xH: 220 mm	L: 580xW: 580xH: 220 mm/900 mm
Koli Boyutları Carton Size	L: 590xW: 590xH: 230 mm	L: 590xW: 590xH: 230 mm/910 mm
Koli İçi Adedi Quantity	1 Adet/Pcs.	1 Adet/Pcs.
Net Ağırlığı Net Weight	6,70 Kg	8,75 Kg
Brüt Ağırlığı Gross Weight	8 Kg	9,85 Kg

İstif Rafı Sistemleri (Demonte) Modular Shelving Systems

Özellikler / Features

- 705 mm'den 1715 mm'ye kadar her 100 mm aralıklarla boyları vardır.
- Demontedir. Ortak ayak kullanımıyla ekonomi sağlar.
- Raf ayakları 32x30 mm alüminyum profilden, traversler 25x42 mm profilden yapılmıştır.
- Alüminyum profiller 20 mikron eloksal kaplı olup -30°C ve +60°C'de sorunsuz kullanılır.
- Kesinlikle paslanmaz, oksitlenme yapmaz.
- Raf tablaları ABS'den olup, HACCP standartlarına uygundur.
- Bulaşık makinesinde yıkanabilir.
- Raf tablaları çıkarılıp yerine GN 1/1 küvet istiflenebilir.
- Raf ara mesafeleri çok kolay değiştirilebilir.
- Her raf 120-150 Kg yüke dayanıklıdır. (4 raflı bir takım 480-600 Kg taşır.)
- U-L modül uygulaması ile en uygun yerleşim yapılabilir.
- Raf sayısını çok kolaylıkla artırabilir ve eksiltilebilirsiniz.
- Montaj için hiçbir alet gerektirmez.
- Ayak yüksekliği 1680 mm'dir.
- Raf tablalarının temizliği çok kolaydır.
- Mutfak içi ve soğuk odalar için çok ekonomiktir.
- Projelerinizde yerleşimi bu raf sistemiyle yaptığınızda toplamdaki ekonomikliğini daha kolay anlayabilirsiniz.
- %100 PASLANMAZLIK VE EKONOMİ

- Anodized aluminum modular shelves easy to assemble without tools.
- Rigid structure with tapered self-locking fittings.
- Maximum hygiene. Heat resistance from -30 to +60 °C.
- These shelves are suitable for cold rooms and storages.
- Solidity and longevity due to anodized aluminum shelves and ABS racks.
- Upright 32x30 cm poles with adjustable feet and 25x42 mm Cross-section profiles made of anodized aluminum.
- Removable ABS shelf racks can be put in the dishwasher up to 90 °C.
- Modularity of line or corner mounting.
- Maximum loading capacity per shelf: 120 – 150 Kg.
- Height: 1680 mm (3, 4, 5 levels) / 1980 mm (4, 5, 6 levels).
- 11 to 13 possible level positions.
- 11 size lengths. It increases by 100 mm between 705 mm up to 1715 mm.
- Rust-free warranty with 20 micron anodized aluminum.



Tribeca

İstif Rafı Sistemleri (Demonte) Modular Shelving Systems

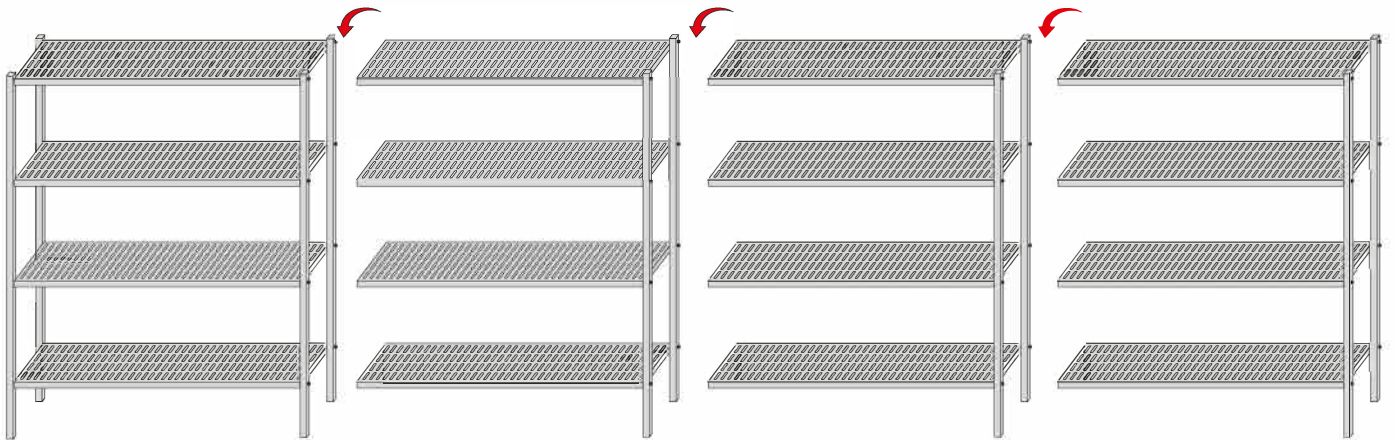
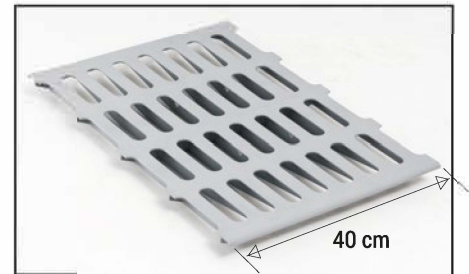
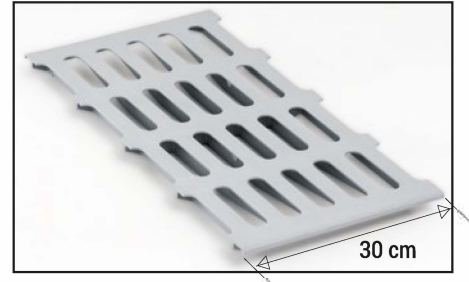

H Model

E Model

E Model

E Model

İstif Rafı Sistemleri (Demonte) Modular Shelving Systems

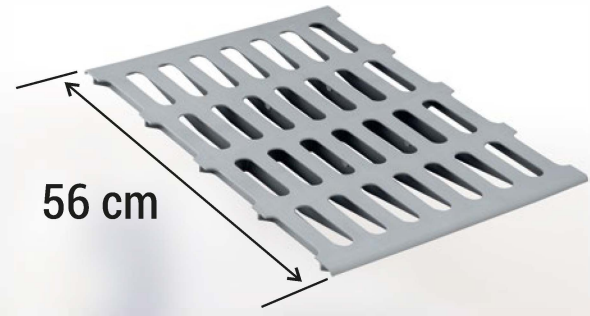

CARTON SIZE: 590x200x1720 mm

H Tipi Raf (Derinlik 56 cm) / H Model Shelf (Depths 56 cm)



H Model

4 Katlı Çift Taraflı Ayaklı Model 4 Shelves Two Side Uprights

Ürün Kodu Code	Ürün Adı Product Name	Ölçüler Dimensions
TS-7056-H	Alüminyum Raf Demonte 4 Katlı Çift Ayaklı Modular Shelving System / Alu. Profile + ABS	700x560x1680
TS-8056-H	Alüminyum Raf Demonte 4 Katlı Çift Ayaklı Modular Shelving System / Alu. Profile + ABS	800x560x1680
TS-9056-H	Alüminyum Raf Demonte 4 Katlı Çift Ayaklı Modular Shelving System / Alu. Profile + ABS	900x560x1680
TS-10056-H	Alüminyum Raf Demonte 4 Katlı Çift Ayaklı Modular Shelving System / Alu. Profile + ABS	1005x560x1680
TS-11056-H	Alüminyum Raf Demonte 4 Katlı Çift Ayaklı Modular Shelving System / Alu. Profile + ABS	1105x560x1680
TS-12056-H	Alüminyum Raf Demonte 4 Katlı Çift Ayaklı Modular Shelving System / Alu. Profile + ABS	1205x560x1680
TS-13056-H	Alüminyum Raf Demonte 4 Katlı Çift Ayaklı Modular Shelving System / Alu. Profile + ABS	1305x560x1680
TS-14156-H	Alüminyum Raf Demonte 4 Katlı Çift Ayaklı Modular Shelving System / Alu. Profile + ABS	1410x560x1680
TS-15156-H	Alüminyum Raf Demonte 4 Katlı Çift Ayaklı Modular Shelving System / Alu. Profile + ABS	1510x560x1680
TS-16156-H	Alüminyum Raf Demonte 4 Katlı Çift Ayaklı Modular Shelving System / Alu. Profile + ABS	1610x560x1680
TS-17156-H	Alüminyum Raf Demonte 4 Katlı Çift Ayaklı Modular Shelving System / Alu. Profile + ABS	1710x560x1680

E Tipi Raf (Derinlik 56 cm) / E Model Shelf (Depths 56 cm)



E Model

4 Katlı Tek Taraflı Ayaklı Model 4 Shelves One Side Uprights

Ürün Kodu Code	Ürün Adı Product Name	Ölçüler Dimensions
TS-65956-E	Alüminyum Raf Demonte 4 Katlı Tek Ayaklı Modular Shelving System / Alu. Profile + ABS	659x560x1680
TS-75956-E	Alüminyum Raf Demonte 4 Katlı Tek Ayaklı Modular Shelving System / Alu. Profile + ABS	759x560x1680
TS-85956-E	Alüminyum Raf Demonte 4 Katlı Tek Ayaklı Modular Shelving System / Alu. Profile + ABS	859x560x1680
TS-96456-E	Alüminyum Raf Demonte 4 Katlı Tek Ayaklı Modular Shelving System / Alu. Profile + ABS	964x560x1680
TS-106456-E	Alüminyum Raf Demonte 4 Katlı Tek Ayaklı Modular Shelving System / Alu. Profile + ABS	1064x560x1680
TS-116456-E	Alüminyum Raf Demonte 4 Katlı Tek Ayaklı Modular Shelving System / Alu. Profile + ABS	1164x560x1680
TS-126456-E	Alüminyum Raf Demonte 4 Katlı Tek Ayaklı Modular Shelving System / Alu. Profile + ABS	1264x560x1680
TS-136956-E	Alüminyum Raf Demonte 4 Katlı Tek Ayaklı Modular Shelving System / Alu. Profile + ABS	1369x560x1680
TS-146956-E	Alüminyum Raf Demonte 4 Katlı Tek Ayaklı Modular Shelving System / Alu. Profile + ABS	1469x560x1680
TS-156956-E	Alüminyum Raf Demonte 4 Katlı Tek Ayaklı Modular Shelving System / Alu. Profile + ABS	1569x560x1680
TS-166956-E	Alüminyum Raf Demonte 4 Katlı Tek Ayaklı Modular Shelving System / Alu. Profile + ABS	1669x560x1680

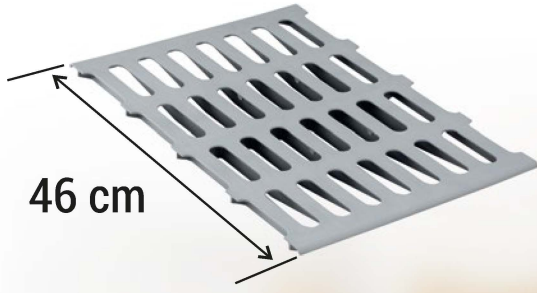

46 cm

İstif Rafı Sistemleri (Demonte) Modular Shelving Systems

CARTON SIZE: 480x200x1720 mm

H Tipi Raf (Derinlik 46 cm) / H Model Shelf (Depths 46 cm)

4 Katlı Çift Taraflı Ayaklı Model 4 Shelves Two Side Uprights

Ürün Kodu Code	Ürün Adı Product Name	Ölçüler Dimensions
TS-7046-H	Alüminyum Raf Demonte 4 Katlı Çift Ayaklı Modular Shelving System / Alu. Profile + ABS	700x460x1680
TS-8046-H	Alüminyum Raf Demonte 4 Katlı Çift Ayaklı Modular Shelving System / Alu. Profile + ABS	800x460x1680
TS-9046-H	Alüminyum Raf Demonte 4 Katlı Çift Ayaklı Modular Shelving System / Alu. Profile + ABS	900x460x1680
TS-100546-H	Alüminyum Raf Demonte 4 Katlı Çift Ayaklı Modular Shelving System / Alu. Profile + ABS	1005x460x1680
TS-110546-H	Alüminyum Raf Demonte 4 Katlı Çift Ayaklı Modular Shelving System / Alu. Profile + ABS	1105x460x1680
TS-120546-H	Alüminyum Raf Demonte 4 Katlı Çift Ayaklı Modular Shelving System / Alu. Profile + ABS	1205x460x1680
TS-130546-H	Alüminyum Raf Demonte 4 Katlı Çift Ayaklı Modular Shelving System / Alu. Profile + ABS	1305x460x1680
TS-14146-H	Alüminyum Raf Demonte 4 Katlı Çift Ayaklı Modular Shelving System / Alu. Profile + ABS	1410x460x1680
TS-15146-H	Alüminyum Raf Demonte 4 Katlı Çift Ayaklı Modular Shelving System / Alu. Profile + ABS	1510x460x1680
TS-16146-H	Alüminyum Raf Demonte 4 Katlı Çift Ayaklı Modular Shelving System / Alu. Profile + ABS	1610x460x1680
TS-17146-H	Alüminyum Raf Demonte 4 Katlı Çift Ayaklı Modular Shelving System / Alu. Profile + ABS	1710x460x1680



H Model

E Tipi Raf (Derinlik 46 cm) / E Model Shelf (Depths 46 cm)

4 Katlı Tek Taraflı Ayaklı Model 4 Shelves One Side Uprights

Ürün Kodu Code	Ürün Adı Product Name	Ölçüler Dimensions
TS-65946-E	Alüminyum Raf Demonte 4 Katlı Tek Ayaklı Modular Shelving System / Alu. Profile + ABS	659x460x1680
TS-75946-E	Alüminyum Raf Demonte 4 Katlı Tek Ayaklı Modular Shelving System / Alu. Profile + ABS	759x460x1680
TS-85946-E	Alüminyum Raf Demonte 4 Katlı Tek Ayaklı Modular Shelving System / Alu. Profile + ABS	859x460x1680
TS-96446-E	Alüminyum Raf Demonte 4 Katlı Tek Ayaklı Modular Shelving System / Alu. Profile + ABS	964x460x1680
TS-106446-E	Alüminyum Raf Demonte 4 Katlı Tek Ayaklı Modular Shelving System / Alu. Profile + ABS	1064x460x1680
TS-116446-E	Alüminyum Raf Demonte 4 Katlı Tek Ayaklı Modular Shelving System / Alu. Profile + ABS	1164x460x1680
TS-126446-E	Alüminyum Raf Demonte 4 Katlı Tek Ayaklı Modular Shelving System / Alu. Profile + ABS	1264x460x1680
TS-136946-E	Alüminyum Raf Demonte 4 Katlı Tek Ayaklı Modular Shelving System / Alu. Profile + ABS	1369x460x1680
TS-146946-E	Alüminyum Raf Demonte 4 Katlı Tek Ayaklı Modular Shelving System / Alu. Profile + ABS	1469x460x1680
TS-156946-E	Alüminyum Raf Demonte 4 Katlı Tek Ayaklı Modular Shelving System / Alu. Profile + ABS	1569x460x1680
TS-166946-E	Alüminyum Raf Demonte 4 Katlı Tek Ayaklı Modular Shelving System / Alu. Profile + ABS	1669x460x1680



E Model

İstif Rafı Sistemleri (Demonte) Modular Shelving Systems

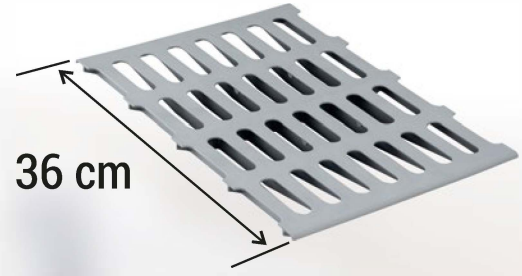

CARTON SIZE: 400x200x1720 mm

H Tipi Raf (Derinlik 36 cm) / H Model Shelf (Depths 36 cm)

4 Katlı Çift Taraflı Ayaklı Model 4 Shelves Two Side Uprights

Ürün Kodu Code	Ürün Adı Product Name	Ölçüler Dimensions
TS-7036-H	Alüminyum Raf Demonte 4 Katlı Çift Ayaklı Modular Shelving System / Alu. Profile + ABS	700x360x1680
TS-8036-H	Alüminyum Raf Demonte 4 Katlı Çift Ayaklı Modular Shelving System / Alu. Profile + ABS	800x360x1680
TS-9036-H	Alüminyum Raf Demonte 4 Katlı Çift Ayaklı Modular Shelving System / Alu. Profile + ABS	900x360x1680
TS-100536-H	Alüminyum Raf Demonte 4 Katlı Çift Ayaklı Modular Shelving System / Alu. Profile + ABS	1005x360x1680
TS-110536-H	Alüminyum Raf Demonte 4 Katlı Çift Ayaklı Modular Shelving System / Alu. Profile + ABS	1105x360x1680
TS-120536-H	Alüminyum Raf Demonte 4 Katlı Çift Ayaklı Modular Shelving System / Alu. Profile + ABS	1205x360x1680
TS-130536-H	Alüminyum Raf Demonte 4 Katlı Çift Ayaklı Modular Shelving System / Alu. Profile + ABS	1305x360x1680
TS-14136-H	Alüminyum Raf Demonte 4 Katlı Çift Ayaklı Modular Shelving System / Alu. Profile + ABS	1410x360x1680
TS-15136-H	Alüminyum Raf Demonte 4 Katlı Çift Ayaklı Modular Shelving System / Alu. Profile + ABS	1510x360x1680
TS-16136-H	Alüminyum Raf Demonte 4 Katlı Çift Ayaklı Modular Shelving System / Alu. Profile + ABS	1610x360x1680
TS-17136-H	Alüminyum Raf Demonte 4 Katlı Çift Ayaklı Modular Shelving System / Alu. Profile + ABS	1710x360x1680



H Model

E Tipi Raf (Derinlik 36 cm) / E Model Shelf (Depths 36 cm)

4 Katlı Tek Taraflı Ayaklı Model 4 Shelves One Side Uprights

Ürün Kodu Code	Ürün Adı Product Name	Ölçüler Dimensions
TS-65936-E	Alüminyum Raf Demonte 4 Katlı Tek Ayaklı Modular Shelving System / Alu. Profile + ABS	659x360x1680
TS-75936-E	Alüminyum Raf Demonte 4 Katlı Tek Ayaklı Modular Shelving System / Alu. Profile + ABS	759x360x1680
TS-85936-E	Alüminyum Raf Demonte 4 Katlı Tek Ayaklı Modular Shelving System / Alu. Profile + ABS	859x360x1680
TS-96436-E	Alüminyum Raf Demonte 4 Katlı Tek Ayaklı Modular Shelving System / Alu. Profile + ABS	964x360x1680
TS-106436-E	Alüminyum Raf Demonte 4 Katlı Tek Ayaklı Modular Shelving System / Alu. Profile + ABS	1064x360x1680
TS-116436-E	Alüminyum Raf Demonte 4 Katlı Tek Ayaklı Modular Shelving System / Alu. Profile + ABS	1164x360x1680
TS-126436-E	Alüminyum Raf Demonte 4 Katlı Tek Ayaklı Modular Shelving System / Alu. Profile + ABS	1264x360x1680
TS-136936-E	Alüminyum Raf Demonte 4 Katlı Tek Ayaklı Modular Shelving System / Alu. Profile + ABS	1369x360x1680
TS-146936-E	Alüminyum Raf Demonte 4 Katlı Tek Ayaklı Modular Shelving System / Alu. Profile + ABS	1469x360x1680
TS-156936-E	Alüminyum Raf Demonte 4 Katlı Tek Ayaklı Modular Shelving System / Alu. Profile + ABS	1569x360x1680
TS-166936-E	Alüminyum Raf Demonte 4 Katlı Tek Ayaklı Modular Shelving System / Alu. Profile + ABS	1669x360x1680



E Model

Çöp Kovaları • Litter Bins



BO 993



BO 992

Pedallı Çöp Kovası • Pedalled Litter Bin

Kod/Code	Litre/Liter	Ebat/Size/mm	No	Koli içi adedi Pcs. in a box
BO 992	80	450x505x730 H	-	3
BO 993	125	510x580x940 H	-	3
BO 994	240	580x710x1050 H	-	3
BO 995	240	580x710x1050 H	-	3
BO 996	120	480x600x960 H	-	3
BO 998	120	480x600x960 H	-	3



Çöp Kovaları • Litter Bins



BO 998
120 lt. Pedallı çöp kovası
120 lt. with pedalled



BO 996



BO 994



BO 994



BO 995
240 lt. Pedallı çöp kovası
240 lt. with pedalled



Pedallı Çöp Kovaları • Pedalled Litter Bins



BO 642



BO 643



BO 176



BO 640



BO 639



BO 641



BO 645

Pedallı, Köşeli Çöp Kovaları • Cornered Pedalled Litter Bins

Kod/Code	Litre/Liter	Ebat/Size/mm	No	Koli içi adedi Pcs. in a box
BO 176	13,5	210x355x340 H		3
BO 639	5	190x270x240 H	1	6
BO 640	10	250x320x290 H	2	6
BO 641	22	300x400x380 H	3	4
BO 645	17	270x380x410 H	3	4
BO 642	48	420x375x630 H	4	1
BO 643	86	440x410x705 H	5	3